

Brånemark System® Mk III Groovy,  
Brånemark System® Mk III TiUnite®  
and Brånemark System® Mk IV  
Procedures manual

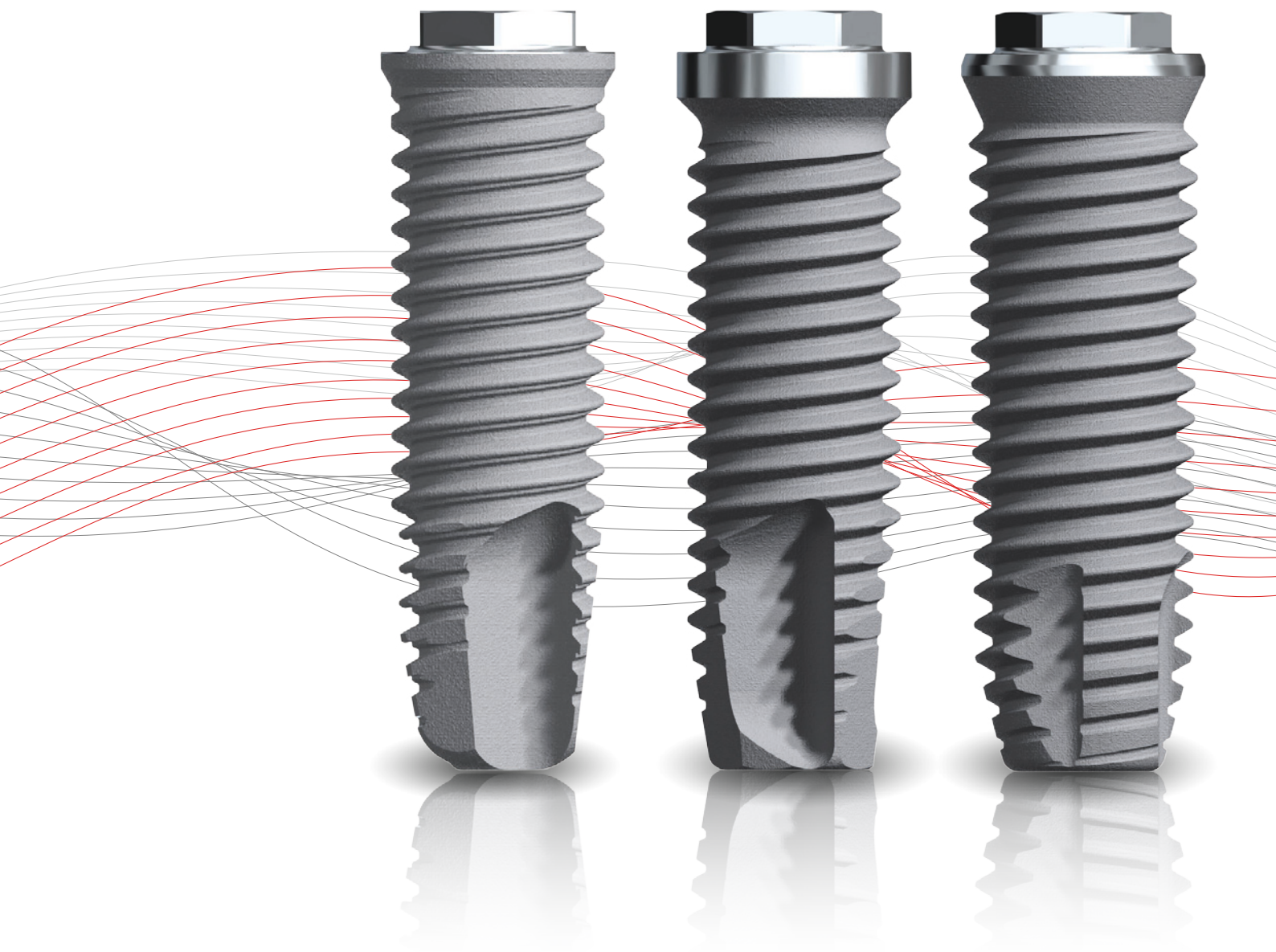

**Note:** In order to improve readability, Nobel Biocare does not use ™ or ® in the running text. By doing so, however, Nobel Biocare does not waive any right to the trademark or registered mark and nothing herein shall be construed to the contrary.

**Disclaimer:** Some products may not be regulatory cleared/released for sale in all markets. Please contact the local Nobel Biocare sales office for current product assortment and availability.

# Contents

<b>Introduction</b>	Quick guide	4
	Brånemark System® Mk III TiUnite®, Mk III Groovy and Mk IV TiUnite®	6
	Platform concept	9
	TiUnite® surface	11
	Implant specifications	12
<b>Surgical procedure</b>	Surgical access	16
	Drilling sequence	17
	Implant insertion	23
	Finalization of implant surgery	26
	Second-stage surgery	27
<b>Restorative procedure</b>	Temporary restorations	30
	Final restorations	34
<b>Product information</b>	Flowcharts	36
	Surgery kits	44
	Implants	47
	Surgical components	49
	Temporary restorations	53
	Impression copings and implant replicas	54
<b>Appendices</b>	Manual torque wrench	55
	Osteotomes	56
	OsseoSet™ 200	57
	Drill stops	58
	Cleaning and sterilization	59
	Customer service worldwide	63

# Quick guide

**Note:** This quick guide shows the placement of a Brånemark System Mk III Groovy RP Ø 3.75 mm implant in medium bone density.

## Flap technique



## Flapless technique

Drill Guide/Twist Drill with Tip Ø 2 mm

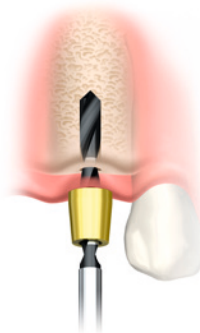

Tissue Punch/Tissue Punch Guide

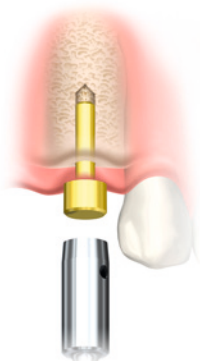

Twist Drill with Tip  
Ø 2.0 mm

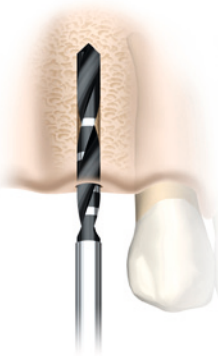

Twist Step Drill  
Ø 2.4/2.8 mm

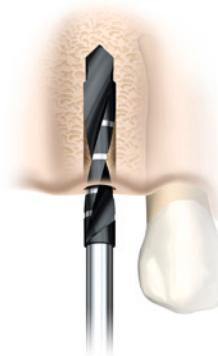

Twist Drill  
Ø 3.0 mm

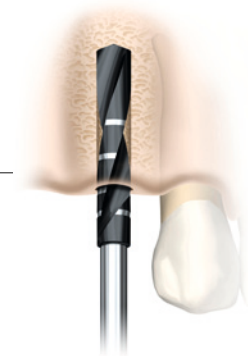

Implant placement

Two-stage  
delayed function

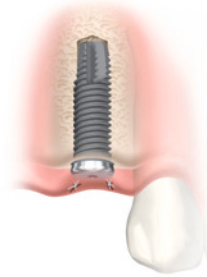

One-stage  
immediate function

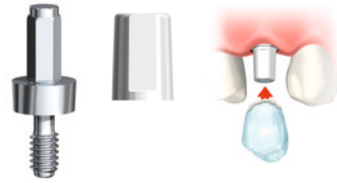

One-stage  
delayed function

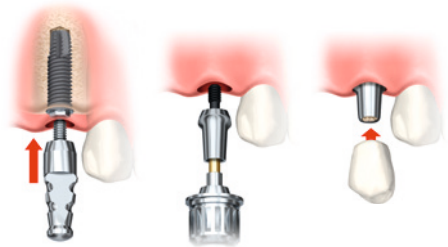
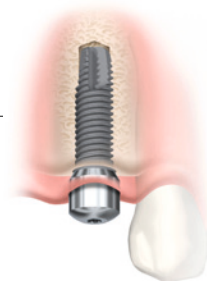

# Brånemark System® Mk III TiUnite®, Mk III Groovy and Mk IV TiUnite®

## Brånemark System® Mk III TiUnite®

### The original implant

- The most scientifically documented implant system in the world, in clinical use for more than 45 years.
- Specially designed for medium to dense bone.

### Exceptional versatility

Available in lengths from 7 to 18 mm with narrow to wide platforms and in several implant diameters featuring a complete prosthetic assortment.



Brånemark System® Mk III Shorty

## Brånemark System® Mk III Groovy

### Differences from Brånemark System Mk III TiUnite

#### Coronal design

- TiUnite on collar designed to preserve crestal bone.
- Threads closer to the abutment seating surface, designed to enhance osseointegration in the marginal area.

#### Groovy

Grooves added to the threads have proven to promote bone growth.

#### Wider tapping chambers

Allow for underpreparation of surgical sites.

#### Slightly rounded apex

Improved ease of insertion.

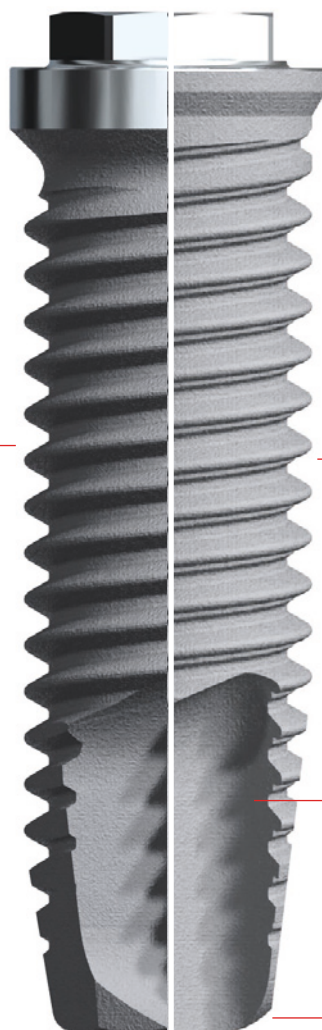

## Brånemark System® Mk IV TiUnite®

### Differences from Brånemark System Mk III TiUnite

#### Flange closer to abutment seating surface

Increased threaded area designed  
to enhance initial stability.

#### Slightly tapered body

Designed to increase initial  
stability in soft bone.

#### Shallow cutting edges on threads

Designed for soft bone  
indications.

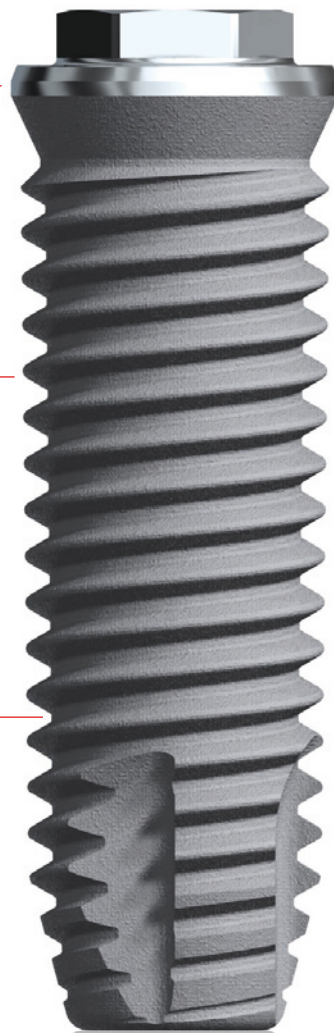

**Optimal stability in all bone qualities**

- General-use, two-piece self-tapping implant system that perform well in soft to hard bone, and one- and two-stage surgical procedures.
- Implant design based on original Brånemark System with parallel walls and three cutting chambers.
- Double-lead threads for fast implant insertion.
- Specially designed drilling protocols to achieve optimal implant stability in all bone qualities.

**Brånemark System Mk III Groovy**

The Brånemark System Mk III Groovy implant has TiUnite up to the level of the platform.

**Brånemark System Mk III TiUnite**

The Brånemark System Mk III TiUnite implant (exception WP implant) has a machined collar of 0.8 mm.

**Brånemark System Mk IV**

Brånemark System Mk IV is a slightly tapered implant recommended in soft and medium bone qualities. The slightly tapered design results in a higher initial implant stability. The implant has a machined collar of 0.4 mm.

Cover screw is co-packed with the Brånemark System Mk III TiUnite and Brånemark System Mk IV implants.

**Brånemark System® Mk III Groovy**



**Brånemark System® Mk III TiUnite®**



**Brånemark System® Mk IV TiUnite®**



**Accurate and secure prosthetic restorations**

- Comprehensive range of prefabricated and individualized restorations, providing precision of fit and excellent esthetics.
- Traditional external hex connection for accurate and secure prosthetic restorations.





# Platform concept



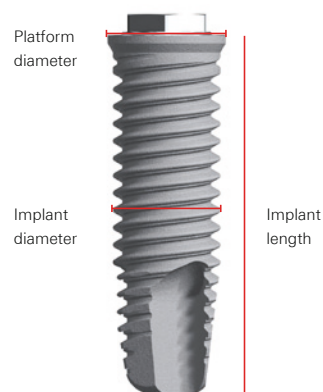

## Platforms

To facilitate treatment planning, clinical procedures, and component identification, Brånemark System implants are organized according to a “platform concept”.





The platform marking corresponds to the implant-abutment interface.





### Brånemark System® Mk III Groovy

Platform	Platform diameter	Implant diameter	Lengths
	Ø 3.5	Ø 3.3	10, 11.5, 13, 15
	Ø 4.1	Ø 3.75	7, 8.5, 10, 11.5, 13, 15, 18
	Ø 4.1	Ø 4.0	7, 8.5, 10, 11.5, 13, 15, 18
	Ø 5.1	Ø 5.0	7, 8.5, 10, 11.5, 13, 15, 18

### Brånemark System® Mk III TiUnite®

Platform	Platform diameter	Implant diameter	Lengths
	Ø 3.5	Ø 3.3	10, 11.5, 13, 15
	Ø 4.1	Ø 3.75	7, 8.5, 10, 11.5, 13, 15, 18
	Ø 4.1	Ø 4.0	7, 8.5, 10, 11.5, 13, 15, 18
	Ø 5.1	Ø 5.0	7, 8.5, 10, 11.5, 13, 15

### Brånemark System® Mk IV TiUnite®

Platform	Platform diameter	Implant diameter	Lengths
	Ø 4.1	Ø 4.0	7, 8.5, 10, 11.5, 13, 15, 18
	Ø 5.1	Ø 5.0	7, 8.5, 10, 11.5, 13, 15

All measurements in mm.

**Narrow platform:** Limited inter-dental space. Not enough alveolar bone for an RP implant.

**Regular platform:** From single anterior tooth loss to full-arch restorations.

**Wide platform:** Where additional loading can be expected. Wider diameter implant/abutment post to build “molar-sized” crown. For higher initial stability in soft bone.

### Minimal distances

Approximate minimal distances between implants (in mm) for restorative simplicity taking the average size of the final restoration (incisors, canines, premolars and molars) into account.

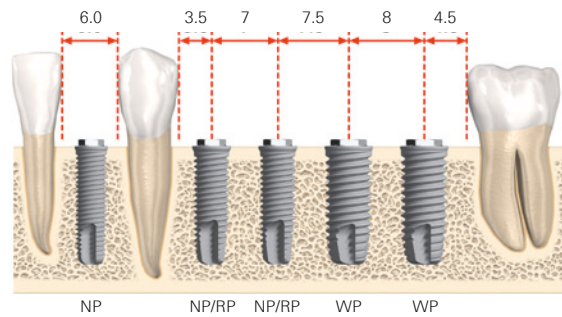

## TiUnite® surface

### Predictable and enhanced osseointegration

TiUnite is Nobel Biocare's patented, moderately rough implant surface that enhances osseointegration by stimulating rapid bone growth.<sup>1</sup>

TiUnite was launched worldwide in 2000. Today, TiUnite is one of the most widely used implant surfaces.

Pre-clinical and clinical results demonstrate that implants with TiUnite offer safe, effective and predictable treatment outcomes.<sup>2</sup>

### With TiUnite:

- Bone begins forming in the early phase of healing.
- Mechanical stability is higher during the healing phase.<sup>3</sup>
- Initial drop in implant stability is reduced, thereby reducing the risk of early implant failure.<sup>3</sup>
- Osseointegration is equal to, or even better, than with calcium phosphate enriched surfaces.<sup>4</sup>
- Implant stability is maintained over time.<sup>5</sup>
- Soft tissue defense system behaves similarly to soft tissue around a natural tooth.<sup>6</sup>
- Clinical efficacy is increased, especially in compromised situations.<sup>1,2</sup>
- Minimal changes in crestal bone levels during healing (stress-free) and under functional loading.<sup>7</sup>
- Long-term success with a cumulative survival rate of 99% after nine years.<sup>8</sup>

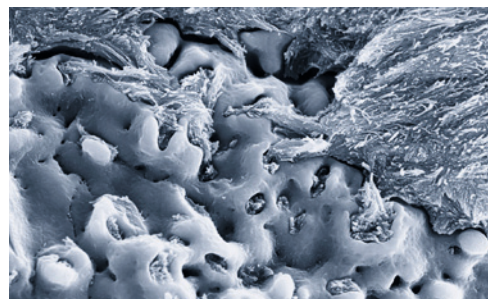

The unique combination of controlled titanium oxide texture and porosity makes bone grow directly onto and into the surface. (Courtesy of Dr Peter Schüpbach, Switzerland)

### Stability maintained over time

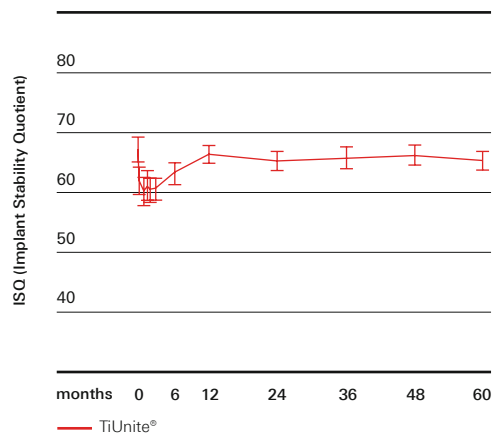

— TiUnite®  
Resonance frequency analysis with mean values expressed in Implant Stability Quotient (ISQ) units and plotted over time; error bars = 95% CI of mean

<sup>1</sup> Compared to machined surface implants. <sup>2</sup> A list of references is available upon request. <sup>3</sup> Glauser R, Portmann M, Ruhstaller P, Lundgren AK, Hämmerle C, Gottlow J. Stability measurements of immediately loaded machined and oxidized implants in the posterior maxilla: a comparative clinical study using resonance frequency analysis. *Appl Osseointegration Res* 2001;2:27-9. <sup>4</sup> Xiropaidis AV, Qahash M, Lim WH, Shanaman RH, Rohrer MD, Wikesjö U ME, Hall J. Bone-implant contact at calcium phosphate-coated and porous titanium oxide (TiUnite) modified oral implants. *Clin Oral Implants Res* 2005;16:532-9. <sup>5</sup> Glauser R, Zembic A, Ruhstaller P, Windisch S. Five-year results of implants with an oxidized surface placed predominantly in soft quality bone and subjected to immediate occlusal loading. *J Prosthet Dent* 2007 Jun;97(6 Suppl):59-68. <sup>6</sup> Schüpbach P, Glauser R. The defense architecture of the human periimplant mucosa: a histological study. *J Prosthet Dent* 2007;97:15-25. <sup>7</sup> Nickenig HJ, Wichmann M, Schlegel KA, Nkenke E, Eitner S. Radiographic evaluation of marginal bone levels adjacent to parallel-screw cylinder machined-neck implants and rough-surfaced microthreaded implants using digitized panoramic radiographs. *Clin Oral Implants Res* 2009;20(6):550-554. <sup>8</sup> George KM, Choi YG, Rieck KL, Van Ess J, Ivancakova R and Carr AB. Immediate restoration with ti-unite implants: practice-based evidence compared with animal study outcomes. *Int J Prosthodont* 2011;24(3):199-203.

# Implant specifications

Brånemark System® Mk III TiUnite®

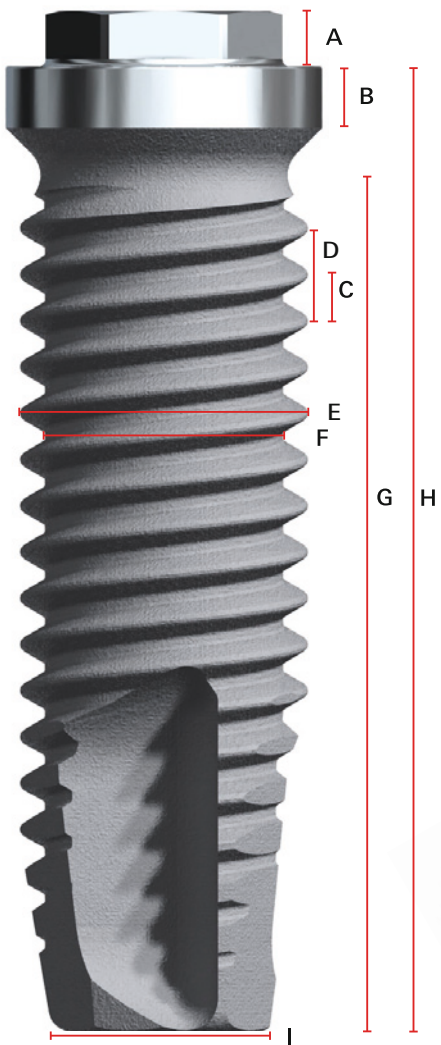

Brånemark System® Mk III Groovy

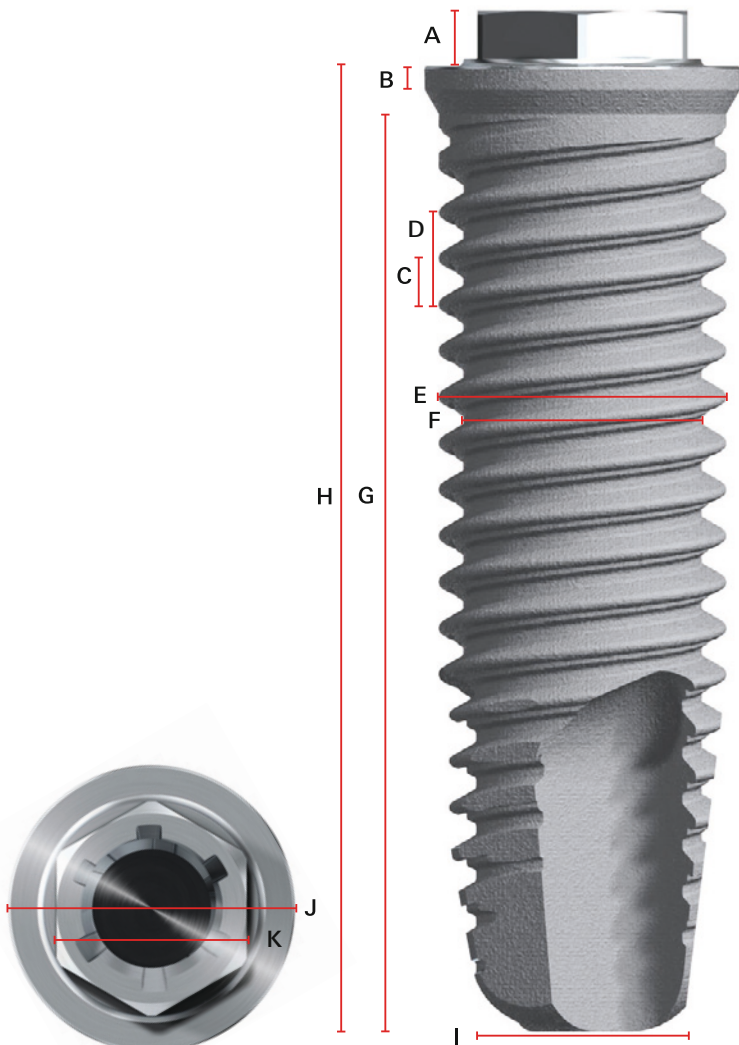

Platform		A	B		C	D	E	F	G		H	I	J	K	
		Hex height	Collar height		Thread spacing	Thread pitch	Major diameter	Minor diameter	Threaded length		Length	Tip diameter	Collar diameter	Hex width	
			Mk III TiUnite	Mk III Groovy	double-lead thread*				Mk III TiUnite	Mk III Groovy					
NP	3.3x10mm	0.7	0.8	0.3	0.5	1.0	3.3	2.8	8.1	9.06	9.5	2.6	3.5	2.4	
	3.3x11.5mm	0.7	0.8	0.3	0.5	1.0	3.3	2.8	9.6	10.56	11.0	2.6	3.5	2.4	
	3.3x13mm	0.7	0.8	0.3	0.5	1.0	3.3	2.8	11.1	12.06	12.5	2.6	3.5	2.4	
	3.3x15mm	0.7	0.8	0.3	0.5	1.0	3.3	2.8	13.1	14.06	14.5	2.6	3.5	2.4	
RP	3.75x7mm Shorty	0.7	0.8	0.3	0.6	1.2	3.73	3.09	5.1	5.91	6.5	2.9	4.1	2.7	
	3.75x8.5mm	0.7	0.8	0.3	0.6	1.2	3.73	3.09	6.6	7.41	8.0	2.9	4.1	2.7	
	3.75x10mm	0.7	0.8	0.3	0.6	1.2	3.73	3.09	8.0	8.91	9.5	2.9	4.1	2.7	
	3.75x11.5mm	0.7	0.8	0.3	0.6	1.2	3.73	3.09	9.5	10.41	11.0	2.9	4.1	2.7	
	3.75x13mm	0.7	0.8	0.3	0.6	1.2	3.73	3.09	11.0	11.91	12.5	2.9	4.1	2.7	
	3.75x15mm	0.7	0.8	0.3	0.6	1.2	3.73	3.09	13.0	13.91	14.5	2.9	4.1	2.7	
RP	3.75x18mm	0.7	0.8	0.3	0.6	1.2	3.73	3.09	16.0	16.91	17.5	2.9	4.1	2.7	
	4x7mm Shorty	0.7	0.8	0.3	0.6	1.2	3.83	3.19	5.2	6.08	6.5	3.1	4.1	2.7	
	4x8.5mm	0.7	0.8	0.3	0.6	1.2	3.83	3.19	6.7	7.58	8.0	3.1	4.1	2.7	
	4x10mm	0.7	0.8	0.3	0.6	1.2	3.83	3.19	8.1	9.08	9.5	3.1	4.1	2.7	
	4x11.5mm	0.7	0.8	0.3	0.6	1.2	3.83	3.19	9.6	10.58	11.0	3.1	4.1	2.7	
	4x13mm	0.7	0.8	0.3	0.6	1.2	3.83	3.19	11.1	12.08	12.5	3.1	4.1	2.7	
RP	4x15mm	0.7	0.8	0.3	0.6	1.2	3.83	3.19	13.1	14.08	14.5	3.1	4.1	2.7	
	4x18mm	0.7	0.8	0.3	0.6	1.2	3.83	3.19	16.1	17.08	17.5	3.1	4.1	2.7	
	WP	5x7mm Shorty	0.7	0.2	0.3	0.8	1.6	4.93	4.08	5.6	6.08	6.5	3.8	5.1	3.4
		5x8.5mm	0.7	0.2	0.3	0.8	1.6	4.93	4.08	7.1	7.58	8.0	3.8	5.1	3.4
		5x10mm	0.7	0.2	0.3	0.8	1.6	4.93	4.08	8.6	9.08	9.5	3.8	5.1	3.4
		5x11.5mm	0.7	0.2	0.3	0.8	1.6	4.93	4.08	10.1	10.58	11.0	3.8	5.1	3.4
5x13mm		0.7	0.2	0.3	0.8	1.6	4.93	4.08	11.6	12.08	12.5	3.8	5.1	3.4	
5x15mm		0.7	0.2	0.3	0.8	1.6	4.93	4.08	13.6	14.08	14.5	3.8	5.1	3.4	
WP	5x18mm	0.7	N/A	0.3	0.8	1.6	4.93	4.08	N/A	17.08	17.5	3.8	5.1	3.4	

All measurements in mm. Sectional measurements do not necessarily add up to total length.

\* The implants move twice the thread spacing with each rotation.

Brånemark System® Mk IV TiUnite®

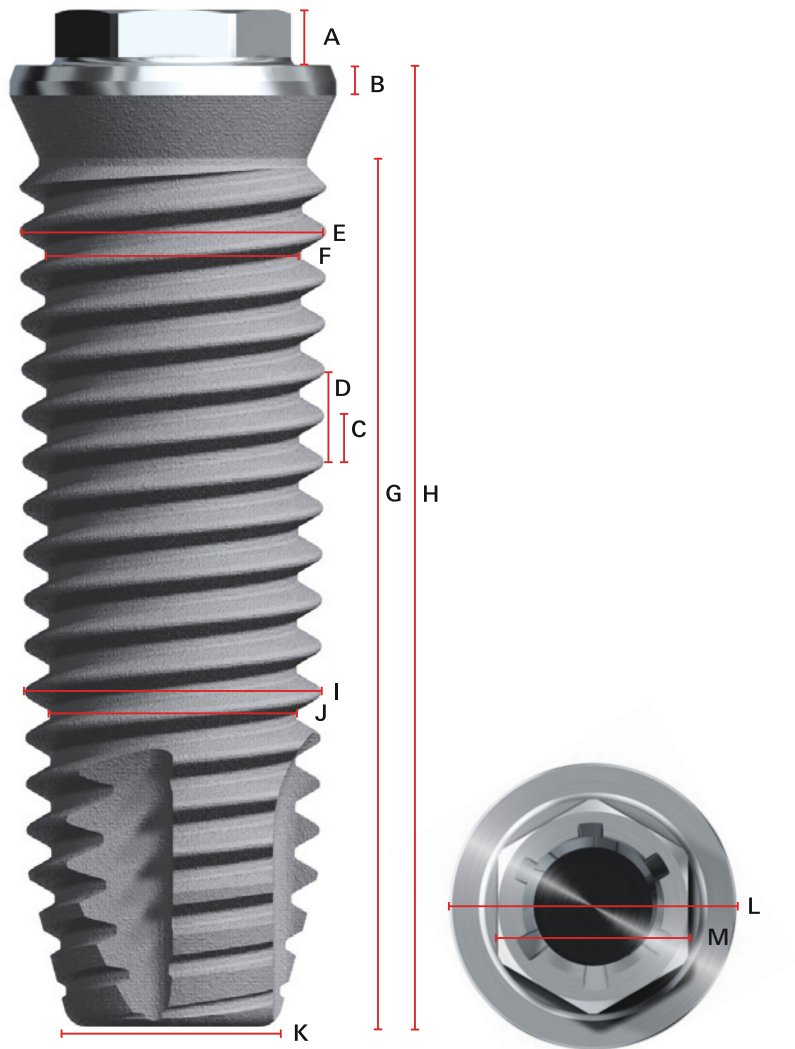

		A	B	C	D	E	F	G	H	I	J	K	L	M
Platform		Hex height	Collar height	Thread spacing	Thread pitch	Major diameter 1	Minor diameter 1	Threaded length	Length	Major diameter 2	Minor diameter 2	Tip diameter	Collar diameter	Hex width
double-lead thread*														
<b>RP</b>	4x7 mm	0.7	0.4	0.6	1.2	4.0	3.36	5.3	6.5	3.8	3.16	2.7	4.1	2.7
	4x8.5 mm	0.7	0.4	0.6	1.2	4.0	3.36	6.8	8.0	3.8	3.16	2.7	4.1	2.7
	4x10 mm	0.7	0.4	0.6	1.2	4.0	3.36	8.3	9.5	3.8	3.16	2.7	4.1	2.7
	4x11.5 mm	0.7	0.4	0.6	1.2	4.0	3.36	9.8	11.0	3.8	3.16	2.7	4.1	2.7
	4x13 mm	0.7	0.4	0.6	1.2	4.0	3.36	11.3	12.5	3.8	3.16	2.7	4.1	2.7
	4x15 mm	0.7	0.4	0.6	1.2	4.0	3.36	13.3	14.5	3.8	3.16	2.7	4.1	2.7
	4x18 mm	0.7	0.4	0.6	1.2	4.0	3.36	16.3	17.5	3.8	3.16	2.7	4.1	2.7
<b>WP</b>	5x7 mm	0.7	0.2	0.8	1.6	4.93	4.09	5.6	6.5	4.73	3.89	3.7	5.1	3.4
	5x8.5 mm	0.7	0.2	0.8	1.6	4.93	4.09	7.1	8.0	4.73	3.89	3.7	5.1	3.4
	5x10 mm	0.7	0.2	0.8	1.6	4.93	4.09	8.6	9.5	4.73	3.89	3.7	5.1	3.4
	5x11.5 mm	0.7	0.2	0.8	1.6	4.93	4.09	10.1	11.0	4.73	3.89	3.7	5.1	3.4
	5x13 mm	0.7	0.2	0.8	1.6	4.93	4.09	11.6	12.5	4.73	3.89	3.7	5.1	3.4
	5x15 mm	0.7	0.2	0.8	1.6	4.93	4.09	13.6	14.5	4.73	3.89	3.7	5.1	3.4

All measurements in mm. Sectional measurements do not necessarily add up to total length.

\* The implants move twice the thread spacing with each rotation.

## Surgical access

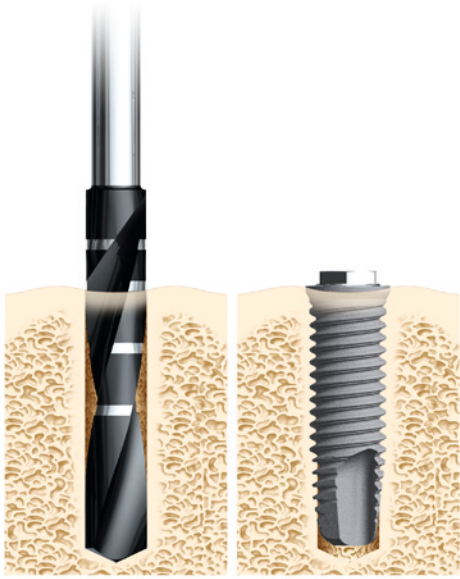

### Standard flap procedure

Used when it is necessary:

- to observe the underlying alveolar bone and adjacent anatomical structures.
- to place bone and/or connective tissue grafts.

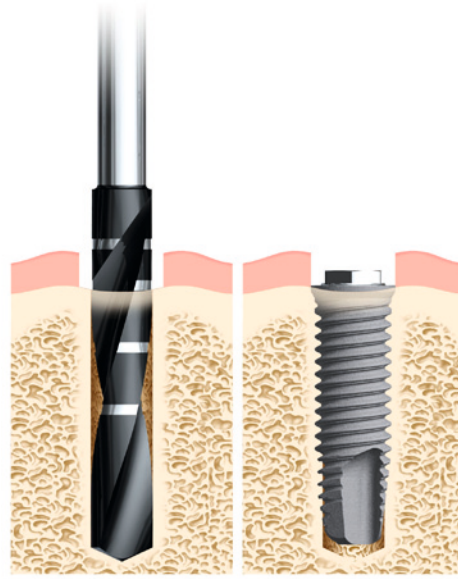

### Flapless procedure

May be used when:

- there is sufficient quantity and quality of alveolar bone and soft tissue.
- it is not necessary to raise a flap to safely direct drilling procedure in relation to the anatomy.

### Notes:

- When using a flapless approach add soft tissue height to drill depth.
- Confirm available bone and significant anatomical landmarks, such as blood vessels, nerves, and concavities. Use conventional diagnostic tools, such as radiographic imaging, probing and palpation, and 3D imaging if indicated.



# Drilling sequence

## Drill technique

The twist and twist step drills are made of stainless steel with an amorphous diamond coating, which gives them their black color. The drills should be used together with copious external irrigation.

- Use an in-and-out motion and drill in bone for 1 to 2 seconds.
- Move the drill up without stopping handpiece motor. This also allows the irrigation to flush away debris.
- Proceed until desired depth is reached in accordance with bone quality and implant diameter.

## Notes:

- Twist, twist step drills, counterbores and screw taps are disposable and should be used for one surgery only.
- Do not re-sterilize disposable drills.
- The twist and twist step drills together with the drilling protocol allow for underpreparation in soft bone for enhanced stability, and provide a passive fit in dense bone.
- In common indications, there is the possibility of fewer drilling steps.
- Stop drilling if there is no irrigation.
- A drill extension shaft may be used to facilitate the procedure. If the drill extension shaft is used together with the drill, external irrigation at the contra-angle should be supplemented. Only use the drill extension shaft with drills.

**Tip:** Irrigate the site with saline solution (using a syringe) to remove bone chips before using the next drill.

## Product reference lines



*\* If the aim is to place the 0.8 mm machined collar subcrestal a counterbore may be used to widen the crestal portion of the site. Compensate for subcrestal implant placement by drilling with the counterbore close to its full length = diamond coated portion in bone.*

## Depth measurement system

The parallel drills have a true depth measurement system: all drills and components are marked to prepare the site to the correct depth and obtain a secure and predictable position.

**Caution:** The drill preparation is up to 1 mm longer than the implant. Allow for this additional length when drilling near vital anatomical structures.

**Note:** The marks on the twist drills indicate actual millimeter lengths and correspond to the top of the implant collar. Final vertical positioning depends on several clinical parameters, including esthetics, tissue thickness and available vertical height.

**Drilling protocols according to bone quality**

**Brånemark System® Mk III Groovy**

Platform	Ø Implant	Soft bone	Medium bone	Dense bone
NP	3.3	Ø 2.0	Ø 2.0	Ø 2.0 Ø 2.4/2.8
RP	3.75	Ø 2.0 (Ø 2.4/2.8)	Ø 2.0 Ø 2.4/2.8 Ø 3.0	Ø 2.0 Ø 2.4/2.8 Ø 3.2
RP	4.0	Ø 2.0 (Ø 2.4/2.8)	Ø 2.0 Ø 2.4/2.8 Ø 3.2	Ø 2.0 Ø 2.4/2.8 Ø 3.4
WP	5.0	Ø 2.0 Ø 2.4/2.8 Ø 3.0	Ø 2.0 Ø 2.4/2.8 Ø 3.2/3.6	Ø 2.0 Ø 2.4/2.8 Ø 3.2/3.6 Ø 3.8/4.2

All data in mm.

**Brånemark System® Mk III TiUnite®**

Platform	Ø Implant	Soft bone	Medium bone	Dense bone
NP	3.3	Ø 2.0 (Ø 2.4/2.8)	Ø 2.0 Ø 2.4/2.8	Ø 2.0 Ø 2.4/2.8
RP	3.75	Ø 2.0 (Ø 2.4/2.8)	Ø 2.0 Ø 2.4/2.8 Ø 3.0	Ø 2.0 Ø 2.4/2.8 Ø 3.2
RP	4.0	Ø 2.0 (Ø 2.4/2.8)	Ø 2.0 Ø 2.4/2.8 Ø 3.2	Ø 2.0 Ø 2.4/2.8 Ø 3.4
WP	5.0	Ø 2.0 Ø 2.4/2.8 (Ø 3.2/3.6)	Ø 2.0 Ø 2.4/2.8 Ø 3.2/3.6 (Ø 3.8/4.2)	Ø 2.0 Ø 2.4/2.8 Ø 3.2/3.6 Ø 3.8/4.2

All data in mm.

**Brånemark System® Mk IV TiUnite®**

Platform	Ø Implant	Soft bone	Medium bone
RP	4.0	Ø 2.0 (Ø 2.4/2.8)	Ø 2.0 Ø 2.4/2.8 Ø 3.2
WP	5.0	Ø 2.0 Ø 2.4/2.8 (Ø 3.2/3.6)	Ø 2.0 Ø 2.4/2.8 Ø 3.2/3.6 (Ø 3.8/4.2)

All data in mm.

**Notes:**

- Drills within brackets (--) denote widening of the cortex only. Counterbores and screw taps are available if deemed necessary.
- For NP implants in extremely soft bone, a Ø 1.5 mm Twist Drill is available.
- Drilling protocol specified on surgical kit plate refers to Brånemark System Mk III Groovy (and NobelSpeedy System Mk III Groovy) implants only.

### Flap procedure

When using a flap procedure, make an incision and raise a flap.



### Flapless procedure: option A

#### Determine implant position

- Drill through gingival tissue and into alveolar crest with the Twist Drill with Tip  $\varnothing$  2 mm.
- Use the Drill Guide to aid proper positioning.
- Drill to 15 mm drill line (measured in relation to the top of the drill guide) for implants 13 mm or longer.

Maximum speed  2000 rpm

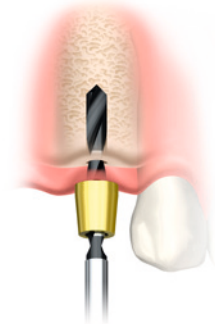

#### Punch the soft tissue

- Insert the appropriate size Tissue Punch Guide into the  $\varnothing$  2 mm pilot hole.
- Connect the Tissue Punch to the contra-angle head and place the punch over the punch guide.
- Using high speed, cut through soft tissue down to the crest.
- Using a scalpel, cut around the tissue plug perpendicular to the alveolar crest to release the tissue plug from the alveolar crest.

**Note:** This technique is recommended only if there is a sufficient amount of attached mucosa. After punching, there should be at least 1 mm of attached mucosa available around the surgical entrance and later around the abutment.

Maximum speed  800 rpm

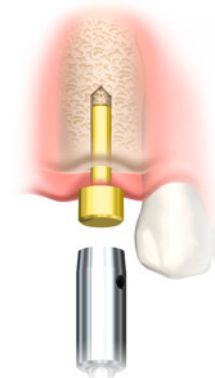
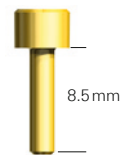

**Flapless procedure: option B**

**Use precision drill**

- To facilitate initial soft tissue penetration and creation of a crestal starting point (also after flap preparation), the Precision Drill can be used before Twist Drill with Tip Ø 2 mm.
- Drill with the precision drill through soft tissue and into the alveolar crest.
- Use the Drill Guide to aid proper positioning when using the flapless approach.

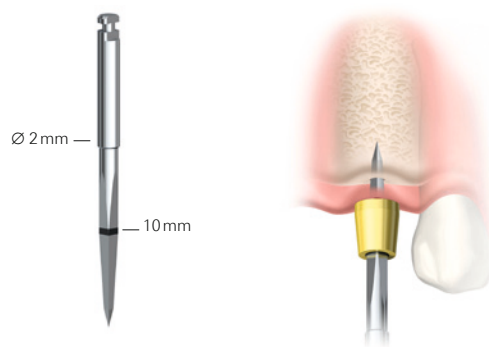

Maximum speed  2000 rpm

The following illustrations show the drilling steps for Brånemark System Mk III Groovy RP Ø 3.75 mm implant in medium bone density. For other implant designs, diameters and bone densities, see page 18.

**1 Drill with Twist Drill with Tip Ø 2 mm**

- Drill to the appropriate depth using the Twist Drill with Tip Ø 2 mm and copious irrigation. Drill stops are available for all diameters to facilitate drilling to correct depth (see appendix).
- When using a flapless procedure, measure tissue thickness with probe. Add the tissue thickness to the drilling depth for correct site preparation. Be aware of anatomical landmarks.



Maximum speed  2000 rpm

**Note:** When placing multiple implants, proceed to next implant site before continuing with next drilling sequence.

**Tip:** Irrigate the site with saline solution (using a syringe) to remove bone chips before using the next drill.

**2 Check osteotomy direction**

- Check correct direction and seating using Direction Indicator Ø 2.0/Ø 2.4–2.8 mm.
- If necessary, adjust site preparation.

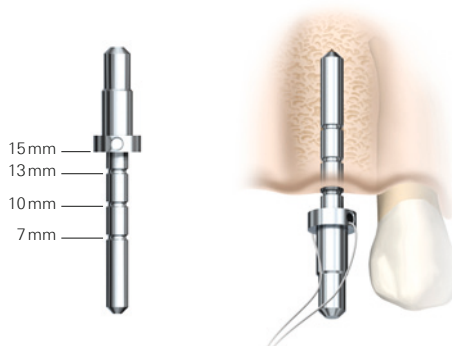

**3 Drill with Twist Step Drill Ø 2.4/2.8 mm**

- Continue site preparation using Twist Step Drill Ø 2.4/2.8 mm.
- Check orientation using Direction Indicator Ø 2.0/Ø 2.4–2.8 mm.

Maximum speed  2000 rpm

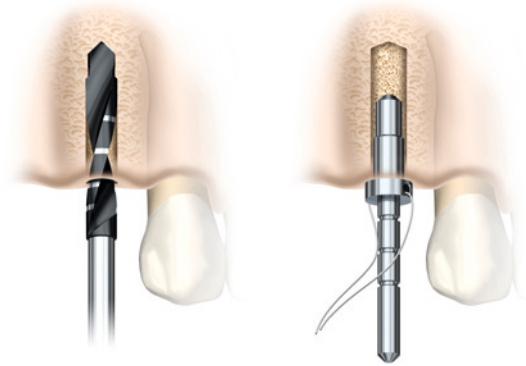

**4 Drill with Twist Drill Ø 3.0 mm**

Finalize site preparation using Twist Drill Ø 3.0 mm.

This is the final drill step for Brånemark System Mk III Groovy RP Ø 3.75 mm implants in medium bone density.

Maximum speed  2000 rpm



**5 Determine implant length**

Determine implant length using the Depth Probe.

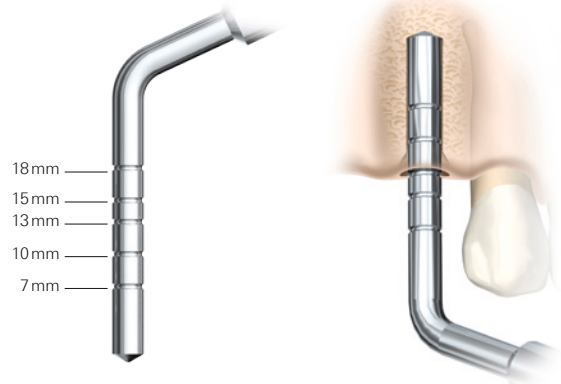

---

### 6 Option: use counterbore

If required, use the counterbore to adapt the implant site to the implant head.

**Note:** Bone quality and marginal cortical layer thickness must be taken into account. The counterbore should remain within the marginal cortical bone to obtain proper implant stability, especially in situations with soft bone.

Maximum speed  2000 rpm



---

### 7 Option: use screw tap

In medium to dense bone, pre-tapping may be required.

- Select the screw tap that matches the diameter of the implant to be placed.
- Insert the screw tap into the prepared implant site using low speed (25 rpm).
- Apply firm pressure and begin rotating the screw tap slowly. When the threads engage, allow screw tap to feed without pressure.
- Switch the handpiece to reverse mode and back the screw tap out.

Low speed  Max 45 Ncm



# Implant insertion

## 1 Unpack implant

Each implant is packaged in a double aseptic vial system. The outer package has a printed label with product data including diameter and length. The inner titanium casing is also marked with implant platform and size.

- Pull the red tab to disengage the plastic shrink-wrap film and unscrew the lid.
- Take out the sterile inner titanium casing and lift off the plastic cap to gain access to implant.
- Record the implant size and LOT number on the patient's chart with the two peel-off labels from the outer vial.

**Note:** No cover screw co-packed with Brånemark System Mk III Groovy implant.

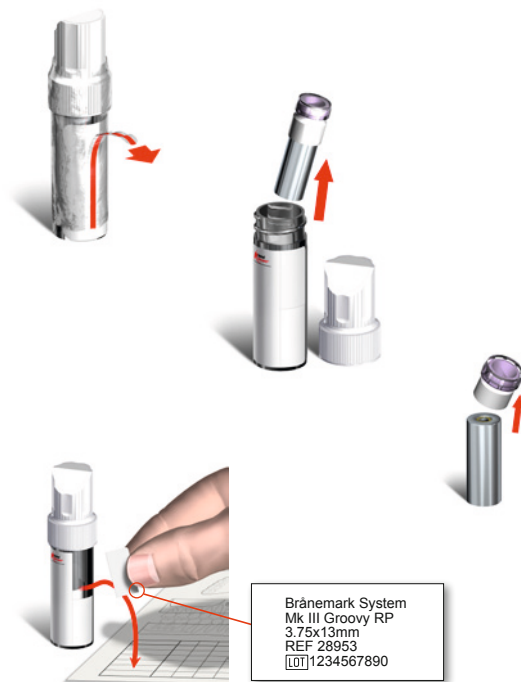

## 2 Pick up implant

- Connect the appropriate implant driver to the handpiece.
- Pick up implant by applying light pressure on the implant driver.

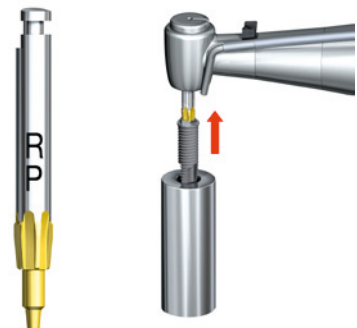

### 3 Insert implant

- Insert the implant into the osteotomy using low speed (25 rpm) and torque between 20–45 Ncm.
- Insert the implant using incremental increase of torque until fully seated. Do not exceed 45 Ncm.
- Ensure that the implant driver is in alignment with the implant during insertion.
- Remove the driver with a gentle upward motion.

Low speed  Max 45 Ncm

**Caution:** Overtightening the implant may lead to damage of the implant, fracture, or necrosis of the bone site.

If the implant gets stuck during implant installation or 45 Ncm is achieved before fully seated, rotate the implant counter-clockwise using drilling machine or manual surgical driver in reverse mode, and remove implant from site.

- Place the implant back into titanium casing before proceeding further.
- Use a wider drill, screw tap or counterbore to widen the site. If screw tap is used place the screw tap into prepared implant site using low speed 25 rpm and drill to appropriate length. Switch the handpiece to reverse mode and back the screw tap out.
- Continue with implant installation until desired position is achieved.

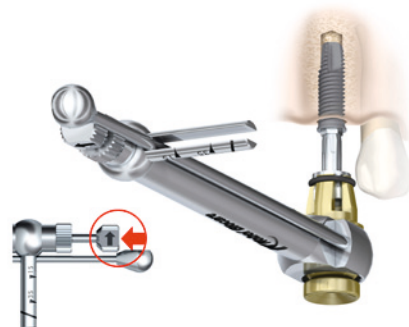

Manual Torque Wrench Surgical in reverse mode for removal of implant



---

#### 4 Adjust and tighten manually

- Connect the appropriate implant driver to the Brånemark System Manual Torque Wrench Surgical and place the implant to its final depth.
- For immediate function, the implant should be able to withstand a final tightening torque of 35–45 Ncm.

#### Caution:

- Do not exceed 45 Ncm.
- If insufficient stability is attained for immediate function, do not load the implant. Wait for sufficient conventional healing (one-stage or two-stage approach).

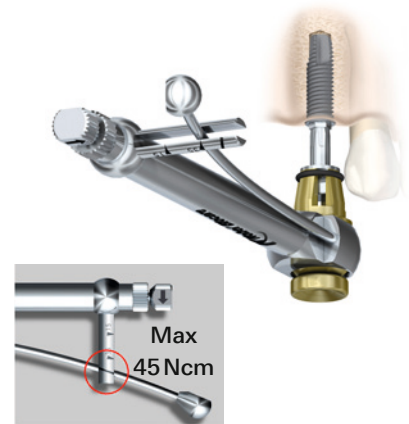

---

#### 5 Place cover screw (for a two-stage surgical approach)

- Place the cover screw on top of the implant using a Cover Screw Driver Brånemark System Hexagon. Make sure that the cover screw is fully seated to prevent bone in-growth between the cover screw and implant platform. Final tightening has to be done manually.
- Close and suture tissue flap around the implant using desired technique.

**Note:** No cover screw is co-packed with the Brånemark System Mk III Groovy implant.

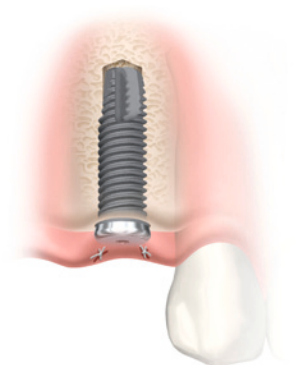

## Finalization of implant surgery

There are three options for finalizing the implant surgery.

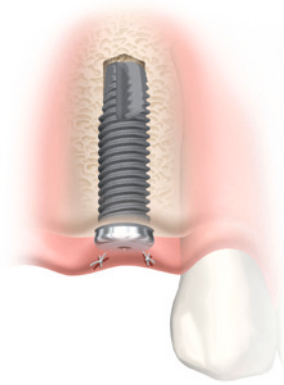

### Two-stage delayed function

Use Cover Screw Driver Brånemark System Hexagon to connect a cover screw to the implant. Suture tissue flap using desired technique.

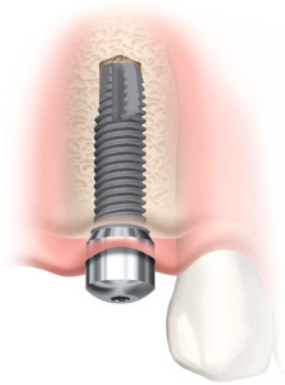

### One-stage delayed function

Use Screwdriver Unigrip to connect a healing abutment to implant. If applicable, suture back the soft tissue.



### One-stage immediate function

Provisionalize implant for immediate esthetics and function, using Nobel Biocare temporary or final abutments.

## Second-stage surgery

The two-stage surgical procedure protects dental implants from inadvertent functional loading by submerging them below the mucosa at the time of placement.

Use two-stage delayed function:

- When a prolonged healing time is desired.
- In compromised cases with decreased healing capacity.
- When extensive and advanced grafting procedures are used.

### Instruments for second-stage surgery



Soft Tissue Punch



Cover Screw Mill



Bone Mill  
manual use



Bone Mill for machine

---

### 1 Uncover the implant

Make an incision to expose cover screw or use the Soft Tissue Punch in case of sufficient amount of attached mucosa.

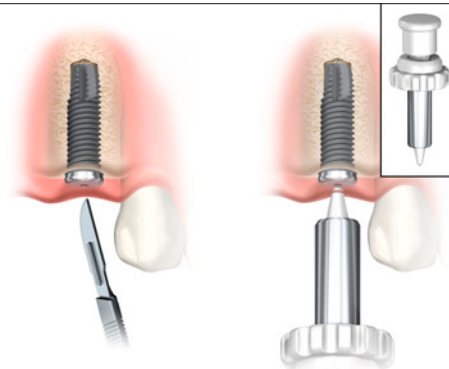

---

### 2 Remove cover screw

- Use Cover Screw Mill to remove any bone overgrowth above cover screw.
- Remove cover screw using Cover Screw Driver Brånemark System Hexagon.

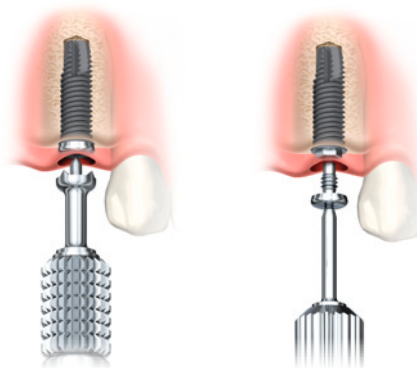

---

### 3 Remove bone overgrowth

- After removing the cover screw, remove any bone around the implant platform that may hinder an abutment from being fully seated on the implant. This is often the case when the implant has been placed below the bone crest. For bone removal, use the Bone Mill Guide and Bone Mill (machine) or Bone Mill (manual) for the corresponding platform.
- The bone mill and guide can be handled either manually (with handle for machine instruments) or with the drilling machine.

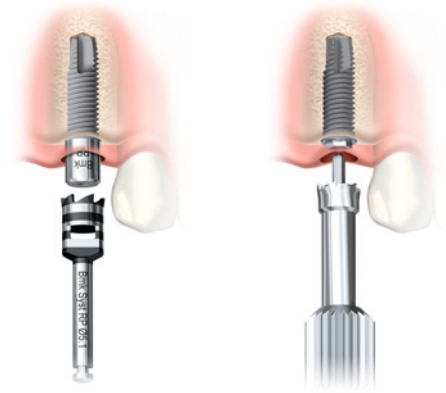

---

### 4 Connect abutment

- Connect suitable healing abutment to implant using Screwdriver Manual Unigrip.
- In case of a prepared flap, suture back the soft tissue.

**Alternative:** If possible, connect the final abutment using corresponding screwdriver.

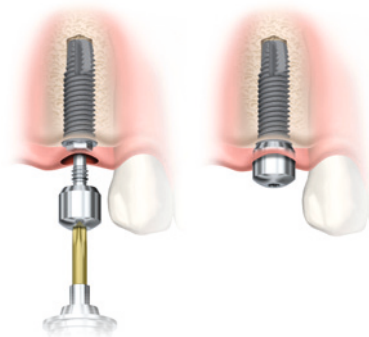

# Temporary restorations

## Temporary single-unit restoration, cement-retained (chair-side procedure)

The following illustrations show the use of the Immediate Temporary Abutment.

Provisionalization must be done in immediate function cases and is a common option for altering the soft tissue after a healing abutment has been used (soft tissue management).

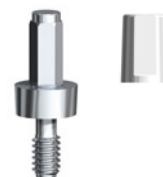

### 1 Connect abutment to implant

- Attach the abutment onto the implant and tighten to 35 Ncm with the Screwdriver Machine Multi-unit and Manual Torque Wrench Prosthetic.
- If the implant rotates while tightening the abutment, re-evaluate primary stability of the implant and consider a submerged approach.



### 2 Adjust the abutment

- Adjust the abutment for height and clearance if necessary.
- Try-in plastic coping (supplied with the abutment) and relieve for clearance if necessary.



### 3 Fabricate and cement temporary crown

- Fabricate a temporary crown with traditional methods using either acrylic or composite.
- If the laboratory has made a prefabricated provisional crown, adjust and reline it to the abutment.
- Cement using temporary cement.

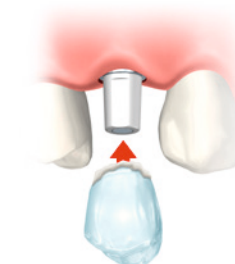

**Warning:** Do not use polyurethane cement with plastic/ temporary copings; the cement will not cure.

**Caution:** In a fresh/open wound, avoid getting any cement below the soft tissue or remove it carefully. Consider using rubber dam or other options to prevent excess cement.

### Temporary multiple-unit restoration, cement-retained (chair-side procedure)

The following illustrations show the use of the QuickTemp Abutment Conical.

Provisionalization must be done in immediate function cases and is a common option for altering the soft tissue after a healing abutment has been used (soft tissue management).



#### 1 Connect abutments to implants

Attach the abutments onto the implants and tighten to 35Ncm with the Screwdriver Unigrip and Manual Torque Wrench Prosthetic.



#### 2 Try-in plastic copings

Try-in the plastic copings; they should securely snap onto the abutments.



#### 3 Make a temporary bridge

- Fabricate a temporary bridge with traditional methods using either acrylic or composite.
- If the laboratory has made a prefabricated provisional bridge, adjust and reline it to the abutments.

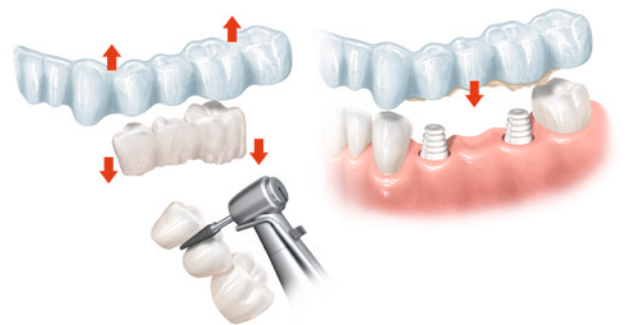

#### 4 Cement bridge on abutments

Cement using temporary cement.

**Warning:** Do not use polyurethane cement with plastic/ temporary copings; the cement will not cure.

**Caution:** In a fresh/open wound, avoid getting any cement below the soft tissue or remove it carefully. Consider using rubber dam or other options to prevent excess cement.



**Temporary multiple-unit restoration, screw-retained  
(chair-side procedure)**

The following illustrations show the use of the Temporary Abutment Non-Engaging (for multiple splinted restorations). For individual implants, use engaging abutments.



Provisionalization must be done in immediate function cases and is a common option for altering the soft tissue after a healing abutment has been used (soft tissue management).

**1 Connect abutments to implants**

- Attach the abutments onto the implants and adjust for height and clearance if necessary.
- Fasten the abutments with guide pins that extend beyond the occlusal plane with the Screwdriver Manual Unigrip.

**Note:** Abutment screw is included with the abutment. Guide pin (available in two lengths: 20 mm [standard length] and 30 mm) has to be ordered separately.

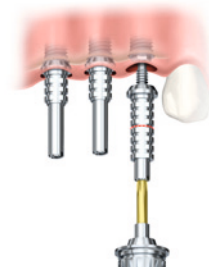

**2 Make acrylic template**

- Fabricate acrylic template for chair-side temporization.
- Make access holes to allow guide pins to protrude.
- If the laboratory has made a prefabricated provisional bridge, make access holes to allow guide pins to protrude (if not already done) and adjust it to the abutments.
- Fill template with acrylic or composite and seat over temporary abutments.

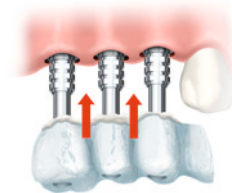



---

### 3 Adjust temporary restoration

- After seating, loosen the guide pins to remove the restoration.
- Trim and polish the restoration. It is important to have a smooth surface adjacent to the surrounding soft tissue.

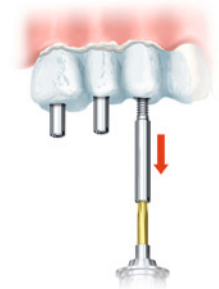

---

### 4 Connect temporary restoration

- Connect the provisional restoration with the supplied abutment screws.
- Tighten to 35Ncm using Manual Torque Wrench Prosthetic and Screwdriver Machine Unigrip.
- Fill screw access holes with suitable material.



# Final restorations

The following illustrations show closed-tray impression taking for a single-unit restoration.

## 1 Place impression coping

- Place the Impression Coping Closed Tray over the implant.
- Use the Screwdriver Unigrip to tighten the screw.
- Block out the Unigrip hole on the guide pin, if applicable.
- A radiograph may be taken to verify proper seating of the impression coping.

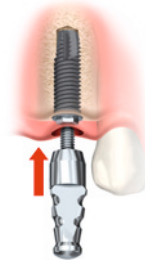

## 2 Take impression

- Inject a heavy body impression material (polyether material or polyvinylsiloxane) around each impression coping and into the tray. Record the impression.
- Remove the impression.
- Remove the impression coping and remove the block-out material. Thread the coping onto the corresponding implant replica.
- Place the impression coping implant replica assembly into its corresponding location in the impression and send it to the dental laboratory for model fabrication.

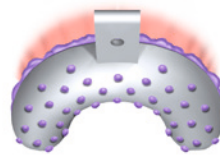

## 3 Laboratory procedures

A final restoration is fabricated using conventional procedures.

## 4 Connect restoration

- Place the abutment onto the implant.
- Tighten to 35Ncm using Manual Torque Wrench Prosthetic and Screwdriver Machine Unigrip.
- Check restoration and cement using appropriate cement.
- Remove excess cement in accordance with normal procedures.
- Check occlusion.

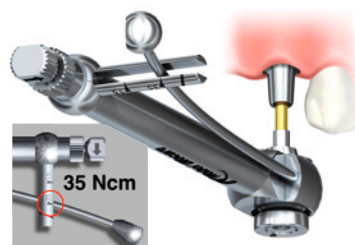







**Note:** A radiograph can help to confirm accurate seating of the abutment.



**Solutions for all indications**

Nobel Biocare offers safe, reliable, and scientifically proven solutions for all clinical and budgetary needs. Restorations include prefabricated and individualized CAD/CAM abutments, single crowns to full-arch bridges, as well as implant bars overdenture. NobelProcera individualized precision-milled restorations deliver superior esthetics, strength, and consistent precision of fit in a full range of materials. For a complete overview of all prefabricated and individualized CAD/CAM restorations, see the Nobel Biocare product catalog.

-  Alumina
-  Zirconia
-  Titanium
-  Base Metal Alloy Cobalt Chromium
-  Telio° CAD (full-contour long-term acrylic temporary)
-  IPS e.max° CAD (full-contour crown)

**Cement-retained solutions on abutments**



NobelProcera® Crown on prefabricated or individualized CAD/CAM abutment



NobelProcera® Bridge on prefabricated or individualized CAD/CAM abutments



NobelProcera® Bridge on prefabricated or individualized CAD/CAM abutments



**Screw-retained solutions on implants and Multi-unit Abutments**



NobelProcera® screw-retained crown



NobelProcera® Implant Bridge (implant level)



NobelProcera® Implant Bridge on Multi-unit Abutments



**Fixed and fixed-removable solutions for edentulous cases**



Prosthesis on Locator® Abutments

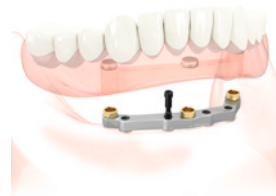

NobelProcera® Implant Bar Overdenture with various attachment systems



NobelProcera® Implant Bridge on Multi-unit Abutments



# Flowchart – Brånemark System® Mk III NP



## Implant



### Brånemark System® Mk III Groovy NP

Length mm	10	11.5	13	15
Ø 3.3mm	32114	32115	32116	32117

*Cover screw not included*



### Brånemark System® Mk III TiUnite® NP

Length mm	10	11.5	13	15
Ø 3.3mm	28906	28907	28908	28909

*Cover screw included*

## Drill

Precision drill	36118
-----------------	-------



## Twist drills

Ø 2 × 7–10mm	32296
Ø 2 × 7–15mm	32297
Ø 2 × 10–18mm	32299



## Twist step drills

Ø 2.4/2.8 × 7–10mm	32260
Ø 2.4/2.8 × 7–15mm	32261
Ø 2.4/2.8 × 10–18mm	32262



## Drill Stop

Ø 2.0mm	33063
Ø 2.8mm	33064



**Counterbore**

Counterbore NP	32281
----------------	-------



**Screw Tap**

10–15 mm	32289
----------	-------



**Implant Driver**

26 mm	29126
34 mm	29127



**Healing Abutment/  
Cover Screw**

**Healing Abutment**

<b>Ø 3.5 mm</b>	
3 mm	33441
5 mm	33442

<b>Ø 4.5 mm</b>	
3 mm	33443
5 mm	33444

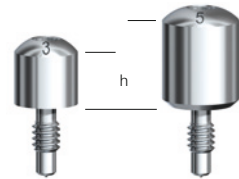

**Cover Screw**

Cover Screw	28986
-------------	-------



# Flowchart – Brånemark System® Mk III RP Ø 3.75 and 4.0 mm



## Implant



### Brånemark System® Mk III Shorty RP

Length mm	7
Ø 3.75 mm	32118

*Cover screw not included*



### Brånemark System® Mk III TiUnite® RP

Length mm	7
Ø 3.75 mm	28911

*Cover screw included*



### Brånemark System® Mk III Groovy RP

Length mm	8.5	10	11.5	13	15	18
Ø 3.75 mm	32119	32120	32121	32122	32123	32124

*Cover screw not included*



### Brånemark System® Mk III TiUnite® RP

Length mm	8.5	10	11.5	13	15	18
Ø 3.75 mm	28912	28913	28914	28915	28916	28917

*Cover screw included*



### Brånemark System® Mk III Shorty RP

Length mm	7
Ø 4.0 mm	32125

*Cover screw not included*



### Brånemark System® Mk III TiUnite® RP

Length mm	7
Ø 4.0 mm	28918

*Cover screw included*



### Brånemark System® Mk III Groovy RP

Length mm	8.5	10	11.5	13	15	18
Ø 4.0 mm	32126	32127	32128	32129	32130	32131

*Cover screw not included*



### Brånemark System® Mk III TiUnite® RP

Length mm	8.5	10	11.5	13	15	18
Ø 4.0 mm	28919	28920	28921	28922	28923	28924

*Cover screw included*

## Drill

Precision drill	36118
-----------------	-------



### Twist drills

Ø 2 × 7–10mm	32296
Ø 2 × 7–15mm	32297
Ø 2 × 10–18mm	32299
Ø 3 × 7–10mm	32266
Ø 3 × 7–15mm	32267
Ø 3 × 10–18mm	32268
Ø 3.2 × 7–10mm	32269
Ø 3.2 × 7–15mm	32270
Ø 3.2 × 10–18mm	32271
Ø 3.4 × 7–10mm	32272
Ø 3.4 × 7–15mm	32273
Ø 3.4 × 10–18mm	32274



### Twist step drills

Ø 2.4/2.8 × 7–10mm	32260
Ø 2.4/2.8 × 7–15mm	32261
Ø 2.4/2.8 × 10–18mm	32262



**Drill Stop**

Ø 2.0 mm	33063
Ø 2.8 mm	33064
Ø 3.0 mm	33075
Ø 3.2 mm	33077
Ø 3.4 mm	33078



**Counterbore**

Counterbore RP	32283
----------------	-------



**Screw Tap**

<b>Ø 3.75 mm</b>	
7-13 mm	32290
7-18 mm	32291



<b>Ø 4.0 mm</b>	
7-13 mm	33072
7-18 mm	33073



**Implant Driver**

21 mm	29129
26 mm	29130
34 mm	29131



**Healing Abutment/  
Cover Screw**

**Healing Abutment**

<b>Ø 4.0 mm</b>	
3 mm	33445
5 mm	33446

<b>Ø 5.0 mm</b>	
3 mm	29137
5 mm	29139

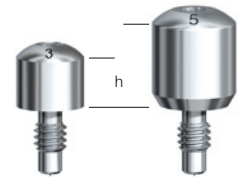

**Cover Screw**

Cover Screw	28987
-------------	-------



# Flowchart – Brånemark System® Mk IV RP



## Implant



### Brånemark System® Mk IV TiUnite® RP

Length mm 7

Ø 4.0mm 28932

*Cover screw included*



### Brånemark System® Mk IV TiUnite® RP

Length mm 8.5 10 11.5 13 15 18

Ø 4.0mm 28933 28934 28935 28936 28937 28938

*Cover screw included*

## Drill

Precision drill	36118
-----------------	-------



### Twist drills

Ø 2 × 7–10mm	32296
Ø 2 × 7–15mm	32297
Ø 2 × 10–18mm	32299
Ø 3 × 7–10mm	32266
Ø 3 × 7–15mm	32267
Ø 3 × 10–18mm	32268
Ø 3.2 × 7–10mm	32269
Ø 3.2 × 7–15mm	32270
Ø 3.2 × 10–18mm	32271
Ø 3.4 × 7–10mm	32272
Ø 3.4 × 7–15mm	32273
Ø 3.4 × 10–18mm	32274



### Twist step drills

Ø 2.4/2.8 × 7–10mm	32260
Ø 2.4/2.8 × 7–15mm	32261
Ø 2.4/2.8 × 10–18mm	32262





**Drill Stop**

Ø 2.0 mm	33063
Ø 2.8 mm	33064
Ø 3.0 mm	33075
Ø 3.2 mm	33077
Ø 3.4 mm	33078



**Counterbore**

Counterbore RP	32283
----------------	-------



**Screw Tap**

<b>Ø 4.0 mm</b>	
7–13 mm	33072
7–18 mm	33073



**Implant Driver**

21 mm	29129
26 mm	29130
34 mm	29131



**Healing Abutment/  
Cover Screw**

**Healing Abutment**

<b>Ø 4.0 mm</b>	
3 mm	33445
5 mm	33446

<b>Ø 5.0 mm</b>	
3 mm	29137
5 mm	29139

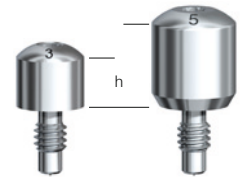

**Cover Screw**

Cover Screw	28987
-------------	-------



# Flowchart – Brånemark System® Mk III WP and Mk IV WP



## Implant

## Drill



### Brånemark System® Mk III Shorty WP

Length mm	7
Ø 5.0mm	32132

Cover screw not included



### Brånemark System® Mk III TiUnite® WP

Length mm	7
Ø 5.0mm	28925

Cover screw included



### Brånemark System® Mk III Groovy WP

Length mm	8.5	10	11.5	13	15	18
Ø 5.0mm	32133	32134	32135	32136	32137	32138

Cover screw not included



### Brånemark System® Mk III TiUnite® WP

Length mm	8.5	10	11.5	13	15	18
Ø 5.0mm	28926	28927	28928	28929	28930	–

Cover screw included



### Brånemark System® Mk IV TiUnite® WP

Length mm	7
Ø 5.0mm	28939

Cover screw included



### Brånemark System® Mk IV TiUnite® WP

Length mm	8.5	10	11.5	13	15	18
Ø 5.0mm	28940	28941	28942	28943	28944	–

Cover screw included

Precision drill	36118
-----------------	-------



### Twist drills

Ø 2 × 7–10mm	32296
Ø 2 × 7–15mm	32297
Ø 2 × 10–18mm	32299
Ø 3 × 7–10mm	32266
Ø 3 × 7–15mm	32267
Ø 3 × 10–18mm	32268



### Twist step drills

Ø 2.4/2.8 × 7–10mm	32260
Ø 2.4/2.8 × 7–15mm	32261
Ø 2.4/2.8 × 10–18mm	32262
Ø 3.2/3.6 × 7–10mm	32263
Ø 3.2/3.6 × 7–15mm	32264
Ø 3.2/3.6 × 10–18mm	32265
Ø 3.8/4.2 × 7–10mm	32275
Ø 3.8/4.2 × 7–15mm	32276
Ø 3.8/4.2 × 10–18mm	32277



**Drill Stop**

Ø 2 mm	33063
Ø 2.8 mm	33064
Ø 3 mm	33075
Ø 3.2 mm	33077
Ø 3.6 mm	33084
Ø 4.2 mm	33081



**Counterbore**

Counterbore WP	32285
----------------	-------



**Screw Tap**

<b>Ø 5.0 mm</b>	
7-13 mm	32292
7-18 mm	32293



**Implant Driver**

21 mm	29134
26 mm	29135



**Healing Abutment/  
Cover Screw**

**Healing Abutment**

<b>Ø 5.0 mm</b>	
3 mm	33447
5 mm	33448

<b>Ø 6.0 mm</b>	
3 mm	29141
5 mm	29143

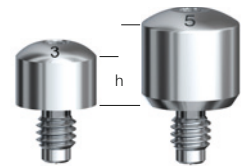

**Cover Screw**

Cover Screw	28988
-------------	-------



# Surgery kits

## 32302 Brånemark System® Surgery Kit

- Includes instruments to perform implant surgery for RP platform.
- Drilling protocol specified on surgical kit plate refers to Brånemark System Mk III Groovy (and NobelSpeedy Groovy) implants only.

**Note:** Instruments for NP and WP platforms need to be ordered separately.

Implants	Soft Bone	Medium Bone	Hard Bone
NP Brnk Syst	1	1	1+2
NP NOBELSPEEDY™	1	1	1+2
RP Brnk Syst ø3.75	1+(2)	1+2+3	1+2+4
RP Brnk Syst ø4	1+(2)	1+2+4	1+2+5
RP NOBELSPEEDY™	1+(2)	1+2+4	1+2+5
WP Brnk Syst ø5	1+2+3	1+2+6	1+2+6+7
WP NOBELSPEEDY™ ø5	1+2+3	1+2+6	1+2+6+7
WP NOBELSPEEDY™ ø6	1+2+6	1+2+6+7	1+2+6+7+8

Kit Plate (32312) includes:

- Unigrip Driver
- Tongue Wrench
- Depth Probe
- Cover Screw Driver
- Implant Driver (NP, RP, WP)
- Wrench Adapter
- Direction Indicator
- Spare

Drill Extension (29164)

Drills (32297\*\* to 32279\*\*):

- Ø 2 mm
- Ø 2.4 / 2.8 mm
- Ø 3 mm
- Ø 3.2 mm
- Ø 3.4 mm
- Ø 3.2 / 3.6 mm
- Ø 3.8 / 4.2 mm
- Ø 5 mm

Other Instruments:

- 29149
- 32110
- 32948
- 32112x4
- DIB 097-0
- 29134\*
- 29135\*
- 29136\*
- 29126\*
- 29128\*
- 29129
- 29130
- 29132

\* Article not included in this kit.

\*\* Article not included in this kit and also available in other lengths.

**Brånemark System® Surgery Kit 32302**  
 (The articles below can also be purchased individually.)

Kit includes instruments for RP platform	
Surgery Kit Box	32312
Implant Driver Brånemark System® RP 21 mm	29129
Implant Driver Brånemark System® RP 26 mm	29130
Implant Driver Wrench Adapter Brånemark System® RP 12 mm	29132
Screwdriver Manual Unigrip™ 28 mm	29149
Cover Screw Driver Brånemark System® Hexagon DIB 097-0	
Drill Extension Shaft	29164
Direction Indicator Ø2/Ø2.4–2.8 mm × 4	32112
Brånemark System® Manual Torque Wrench Surgical	32110
Depth Probe	32948
Implant/Prosthetic Organizer	29532
Brånemark System® Wall chart	33129
Brånemark System® NobelSpeedy® Radiographic Template	33097
Implant Sleeve Holder	29543

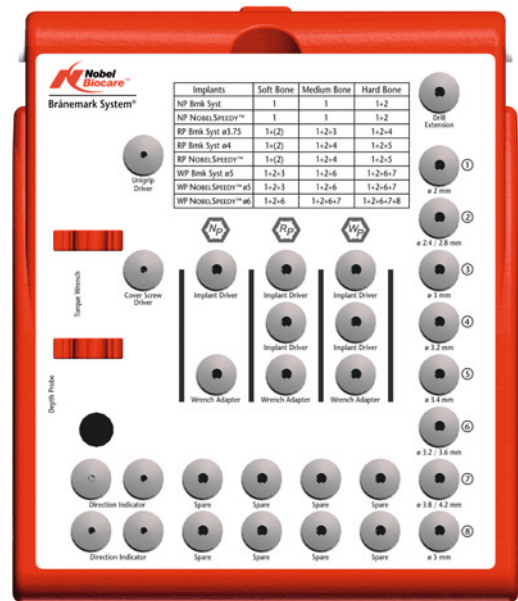

**Notes:**

- Instruments for NP and WP platforms need to be ordered separately.
- Drills are available for separate purchase and are not included in the kit.

**Brånemark System® Second-stage Surgery Kit 32308**

(The articles below can also be purchased individually.)

Kit includes	
Brånemark System® Second Stage Surgery Kit Box	32315
Bone Mill Brånemark System® NP	28977
Bone Mill Brånemark System® RP	28978
Bone Mill Brånemark System® WP	28979
Cover Screw Mill Brånemark System® NP	28980
Cover Screw Mill Brånemark System® RP	28981
Cover Screw Mill Brånemark System® WP	28982
Cover Screw Driver Brånemark System® Hexagon	DIB 097-0
Screwdriver Manual Unigrip™ 28 mm	29149

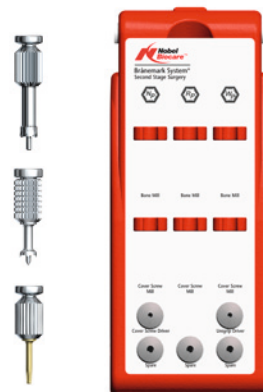

Machine Bone Mill and Bone Mill Guide see page 51

**Nobel Biocare® Flapless Surgery Kit 32304**

(The articles below can also be purchased individually.)

Kit includes	
Nobel Biocare® Flapless Surgery Kit Box	32317
Tissue Punch NP	29628
Tissue Punch RP	29629
Tissue Punch WP	29630
Tissue Punch 6.0	32672
Tissue Punch Guide NP	29631
Tissue Punch Guide RP	29632
Tissue Punch Guide WP	29633
Tissue Punch Guide 6.0	32673
Drill Guide NP	29634
Drill Guide RP	29635
Drill Guide WP	29636
Drill Guide 6.0	32674



**Prosthetic Kit 32309**

(The articles below can also be purchased individually.)





Kit includes	
Prosthetic Kit Box	32322
Manual Torque Wrench Prosthetic	29165
Screwdriver Machine Unigrip 20 mm	29151
Screwdriver Machine Unigrip 30 mm	29153
Screwdriver Machine Multi-unit 21 mm	29158



# Implants



---

## Brånemark System® Mk III Groovy and Shorty

Brånemark System® Mk III Groovy NP 3.3 × 10 mm	32114		
Brånemark System® Mk III Groovy NP 3.3 × 11.5 mm	32115		
Brånemark System® Mk III Groovy NP 3.3 × 13 mm	32116		
Brånemark System® Mk III Groovy NP 3.3 × 15 mm	32117		
Brånemark System® Mk III Shorty RP 3.75 × 7 mm	32118		
Brånemark System® Mk III Groovy RP 3.75 × 8.5 mm	32119		
Brånemark System® Mk III Groovy RP 3.75 × 10 mm	32120		
Brånemark System® Mk III Groovy RP 3.75 × 11.5 mm	32121		
Brånemark System® Mk III Groovy RP 3.75 × 13 mm	32122		
Brånemark System® Mk III Groovy RP 3.75 × 15 mm	32123		
Brånemark System® Mk III Groovy RP 3.75 × 18 mm	32124		
Brånemark System® Mk III Shorty RP 4.0 × 7 mm	32125		
Brånemark System® Mk III Groovy RP 4.0 × 8.5 mm	32126		
Brånemark System® Mk III Groovy RP 4.0 × 10 mm	32127		
Brånemark System® Mk III Groovy RP 4.0 × 11.5 mm	32128		
Brånemark System® Mk III Groovy RP 4.0 × 13 mm	32129		
Brånemark System® Mk III Groovy RP 4.0 × 15 mm	32130		
Brånemark System® Mk III Groovy RP 4.0 × 18 mm	32131		
Brånemark System® Mk III Shorty WP 5.0 × 7 mm	32132		
Brånemark System® Mk III Groovy WP 5.0 × 8.5 mm	32133		
Brånemark System® Mk III Groovy WP 5.0 × 10 mm	32134		
Brånemark System® Mk III Groovy WP 5.0 × 11.5 mm	32135		
Brånemark System® Mk III Groovy WP 5.0 × 13 mm	32136		
Brånemark System® Mk III Groovy WP 5.0 × 15 mm	32137		
Brånemark System® Mk III Groovy WP 5.0 × 18 mm	32138		

---

**Brånemark System® Mk III TiUnite®**

Brånemark System® Mk III TiUnite® NP 3.3 × 10 mm	28906		
Brånemark System® Mk III TiUnite® NP 3.3 × 11.5 mm	28907		
Brånemark System® Mk III TiUnite® NP 3.3 × 13 mm	28908		
Brånemark System® Mk III TiUnite® NP 3.3 × 15 mm	28909		

Brånemark System® Mk III TiUnite® RP 3.75 × 7 mm	28911	
Brånemark System® Mk III TiUnite® RP 3.75 × 8.5 mm	28912	
Brånemark System® Mk III TiUnite® RP 3.75 × 10 mm	28913	
Brånemark System® Mk III TiUnite® RP 3.75 × 11.5 mm	28914	
Brånemark System® Mk III TiUnite® RP 3.75 × 13 mm	28915	
Brånemark System® Mk III TiUnite® RP 3.75 × 15 mm	28916	
Brånemark System® Mk III TiUnite® RP 3.75 × 18 mm	28917	

Brånemark System® Mk III TiUnite® RP 4.0 × 7 mm	28918	
Brånemark System® Mk III TiUnite® RP 4.0 × 8.5 mm	28919	
Brånemark System® Mk III TiUnite® RP 4.0 × 10 mm	28920	
Brånemark System® Mk III TiUnite® RP 4.0 × 11.5 mm	28921	
Brånemark System® Mk III TiUnite® RP 4.0 × 13 mm	28922	
Brånemark System® Mk III TiUnite® RP 4.0 × 15 mm	28923	
Brånemark System® Mk III TiUnite® RP 4.0 × 18 mm	28924	

Brånemark System® Mk III TiUnite® WP 5.0 × 7 mm	28925	
Brånemark System® Mk III TiUnite® WP 5.0 × 8.5 mm	28926	
Brånemark System® Mk III TiUnite® WP 5.0 × 10 mm	28927	
Brånemark System® Mk III TiUnite® WP 5.0 × 11.5 mm	28928	
Brånemark System® Mk III TiUnite® WP 5.0 × 13 mm	28929	
Brånemark System® Mk III TiUnite® WP 5.0 × 15 mm	28930	

**Brånemark System® Mk IV TiUnite®**

Brånemark System® Mk IV TiUnite® RP 4.0 × 7 mm	28932		
Brånemark System® Mk IV TiUnite® RP 4.0 × 8.5 mm	28933		
Brånemark System® Mk IV TiUnite® RP 4.0 × 10 mm	28934		
Brånemark System® Mk IV TiUnite® RP 4.0 × 11.5 mm	28935		
Brånemark System® Mk IV TiUnite® RP 4.0 × 13 mm	28936		
Brånemark System® Mk IV TiUnite® RP 4.0 × 15 mm	28937		
Brånemark System® Mk IV TiUnite® RP 4.0 × 18 mm	28938		

Brånemark System® Mk IV TiUnite® WP 5.0 × 7 mm	28939	
Brånemark System® Mk IV TiUnite® WP 5.0 × 8.5 mm	28940	
Brånemark System® Mk IV TiUnite® WP 5.0 × 10 mm	28941	
Brånemark System® Mk IV TiUnite® WP 5.0 × 11.5 mm	28942	
Brånemark System® Mk IV TiUnite® WP 5.0 × 13 mm	28943	
Brånemark System® Mk IV TiUnite® WP 5.0 × 15 mm	28944	



# Surgical components

---

## Tissue Punches

Tissue Punch NP	29628
Tissue Punch RP	29629
Tissue Punch WP	29630



---

## Tissue Punch Guides

Tissue Punch Guide NP	29631
Tissue Punch Guide RP	29632
Tissue Punch Guide WP	29633



---

## Drill Guides

Drill Guide NP	29634
Drill Guide RP	29635
Drill Guide WP	29636



---

## Soft Tissue Punches

Soft Tissue Punch Ø 4.1 mm, 5/pkg	32Z2000
Soft Tissue Punch Ø 5.2 mm, 5/pkg	32Z2002
Soft Tissue Punch Ø 6.2 mm, 5/pkg	32Z2004



**Drills**

Precision Drill	36118
Twist Drill 1.5 × 7–15 mm	31278
Twist Drill with Tip 2 × 7–10 mm	32296
Twist Drill with Tip 2 × 7–15 mm	32297
Twist Drill with Tip 2 × 10–18 mm	32299
Twist Drill 3 × 7–10 mm	32266
Twist Drill 3 × 7–15 mm	32267
Twist Drill 3 × 10–18 mm	32268
Twist Drill 3.2 × 7–10 mm	32269
Twist Drill 3.2 × 7–15 mm	32270
Twist Drill 3.2 × 10–18 mm	32271
Twist Drill 3.4 × 7–10 mm	32272
Twist Drill 3.4 × 7–15 mm	32273
Twist Drill 3.4 × 10–18 mm	32274
Twist Step Drill 2.4/2.8 7–10 mm	32260
Twist Step Drill 2.4/2.8 7–15 mm	32261
Twist Step Drill 2.4/2.8 10–18 mm	32262
Twist Step Drill 2.8/3.2 7–15 mm	34638
Twist Step Drill 2.8/3.2 10–18 mm	34639
Twist Step Drill 3.2/3.6 7–10 mm	32263
Twist Step Drill 3.2/3.6 7–15 mm	32264
Twist Step Drill 3.2/3.6 10–18 mm	32265
Twist Step Drill 3.8/4.2 7–10 mm	32275
Twist Step Drill 3.8/4.2 7–15 mm	32276
Twist Step Drill 3.8/4.2 10–18 mm	32277
Twist Step Drill 4.2/4.6 7–15 mm	34582
Twist Step Drill 4.2/4.6 10–18 mm	34583
Drill Kit 7–15 mm	35425

**35425 Drill Kit 7–15 mm includes:**

32297 Twist Drill with Tip 2 × 7–15 mm



32261 Twist Step Drill 2.4/2.8 7–15 mm



35426 Guide Drill

**Counterbores**

Brånemark System® Counterbore NP	32281
Brånemark System® Counterbore RP	32283
Brånemark System® Counterbore WP	32285

**Screw Taps**

Screw Tap NP 10–15 mm	32289
Screw Tap RP Ø 3.75 7–13 mm	32290
Screw Tap RP Ø 3.75 7–18 mm	32291
Screw Tap RP Ø 4 7–13 mm	33072
Screw Tap RP Ø 4 7–18 mm	33073
Screw Tap WP Ø 5 7–13 mm	32292
Screw Tap WP Ø 5 7–18 mm	32293



---

 Direction Indicator Ø 2/Ø 2.4–2.8 mm

32112



---

**Implant Drivers**

Implant Driver Brånemark System® NP 26 mm

29126

Implant Driver Brånemark System® NP 34 mm

29127

Implant Driver Brånemark System® RP 21 mm

29129

Implant Driver Brånemark System® RP 26 mm

29130

Implant Driver Brånemark System® RP 34 mm

29131

Implant Driver Brånemark System® WP 21 mm

29134

Implant Driver Brånemark System® WP 26 mm

29135



---

**Bone Mills and Guides (machine)**

Bone Mill Guide Brånemark System® NP

33496

Bone Mill Guide Brånemark System® RP

33497

Bone Mill Guide Brånemark System® WP

33498

Bone Mill with Guide Brånemark System® NP Ø 4.5 mm

33392

Bone Mill with Guide Brånemark System® RP Ø 5.1 mm

33393

Bone Mill with Guide Brånemark System® WP Ø 6.5 mm

33495



---

**Bone Mills (manual)**

Bone Mill Brånemark System® NP

28977

Bone Mill Brånemark System® RP

28978

Bone Mill Brånemark System® WP

28979



---

 Handle for machine instruments

29161

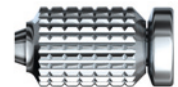

---

 Implant Retrieval Tool

36139



The implant retrieval tool can be used to remove implants NP and RP in case the implant connection has been damaged and the ordinary implant driver cannot be used to remove the implant. It has an external hexagonal fitting that fits the Manual Torque Wrench Surgical (Art. No. 28839) including the Manual Torque Wrench Adapter (Art. No. 28840). The implant retrieval tool is for single use only and is delivered sterile.

---

**Cover Screws**

Cover Screw Brånemark System® NP

28986

Cover Screw Brånemark System® RP

28987

Cover Screw Brånemark System® WP

28988



**Manual Torque Wrench**

Brånemark System® Manual Torque Wrench Surgical	32110
Brånemark System® Manual Torque Wrench Adapter Surgical	32111
Manual Torque Wrench Prosthetic	29165
Manual Torque Wrench Adapter Prosthetic	29167



**Screwdrivers**

Screwdriver Machine Unigrip™ 20mm	29151
Screwdriver Machine Unigrip™ 25mm	29152
Screwdriver Machine Unigrip™ 30mm	29153
Screwdriver Machine Unigrip™ 35mm	29154
Screwdriver Manual Unigrip™ 20mm	29148
Screwdriver Manual Unigrip™ 28mm	29149
Screwdriver Manual Unigrip™ 36mm	29150

Cover Screw Driver Brånemark System® Hexagon DIB 097-0

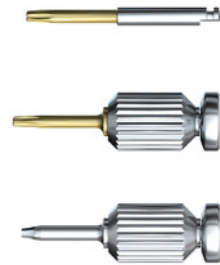

Surgical Drape Kit 2-pack 12T7400



Drill Extension Shaft 29164



Surgical Driver 32180









Nobel Biocare® Osteotome Kit 32321



# Temporary restorations

The following temporary abutments are the ones shown in this procedures manual.  
For the full assortment of abutments, see the Nobel Biocare product catalog.

## Temporary Abutments

Immediate Temporary Abutment Brånemark System® NP	31643	
Immediate Temporary Abutment Brånemark System® RP	31644	
Immediate Temporary Abutment Brånemark System® WP	31655	
Plastic Coping Immediate Temporary Abutment	31656	
QuickTemp™ Abutment Conical Brånemark System® NP	33401	
QuickTemp™ Abutment Conical Brånemark System® RP	33402	
QuickTemp™ Abutment Conical Brånemark System® WP	33403	
Plastic Coping QuickTemp™ Abutment Conical	33404	
Temporary Abutment Non-Engaging Brånemark System® NP	29029	
Temporary Abutment Non-Engaging Brånemark System® RP	29031	
Temporary Abutment Non-Engaging Brånemark System® WP	29033	
Temporary Abutment Engaging Brånemark System® NP	29028	
Temporary Abutment Engaging Brånemark System® RP	29030	
Temporary Abutment Engaging Brånemark System® WP	29032	

## Healing Abutments

Healing Abutment Brånemark System® NP Ø 3.5 × 3 mm	33441	
Healing Abutment Brånemark System® NP Ø 3.5 × 5 mm	33442	
Healing Abutment Brånemark System® NP Ø 4.5 × 3 mm	33443	
Healing Abutment Brånemark System® NP Ø 4.5 × 5 mm	33444	
Healing Abutment Brånemark System® RP Ø 4 × 3 mm	33445	
Healing Abutment Brånemark System® RP Ø 4 × 5 mm	33446	
Healing Abutment Brånemark System® RP Ø 5 × 3 mm	29137	
Healing Abutment Brånemark System® RP Ø 5 × 5 mm	29139	
Healing Abutment Brånemark System® WP Ø 5 × 3 mm	33447	
Healing Abutment Brånemark System® WP Ø 5 × 5 mm	33448	
Healing Abutment Brånemark System® WP Ø 6 × 3 mm	29141	
Healing Abutment Brånemark System® WP Ø 6 × 5 mm	29143	

# Impression copings and implant replicas

For the full assortment of impression copings see the Nobel Biocare Product Catalog.

---

## Impression Copings Closed Tray

Impression Coping Closed Tray Brånemark System® NP Ø3.5 mm	33462
Impression Coping Closed Tray Brånemark System® NP Ø4.5 mm	33463
Impression Coping Closed Tray Brånemark System® RP Ø4.0 mm	33464
Impression Coping Closed Tray Brånemark System® RP Ø5.0 mm	29073
Impression Coping Closed Tray Brånemark System® WP Ø5.0 mm	33465
Impression Coping Closed Tray Brånemark System® WP Ø6.0 mm	29075



---

## Impression Copings Open Tray

Impression Coping Open Tray Brånemark System® NP Ø3.5 mm	33458
Impression Coping Open Tray Brånemark System® NP Ø4.5 mm	33459
Impression Coping Open Tray Brånemark System® RP Ø4.0 mm	33460
Impression Coping Open Tray Brånemark System® RP Ø5.0 mm	29072
Impression Coping Open Tray Brånemark System® WP Ø5.0 mm	33461
Impression Coping Open Tray Brånemark System® WP Ø6.0 mm	29074



---

## Implant Replicas

Implant Replica Brånemark System® NP	31158
Implant Replica Brånemark System® RP	31159
Implant Replica Brånemark System® RP 5/pkg	29108
Implant Replica Brånemark System® WP	31160



# Manual torque wrench

For the surgeon, the torque required to place implants provides insight into the initial stability of the implant. For restorative procedures, tightening the abutment and prosthetic screws to recommended torque specifications will more effectively control screw-joint integrity during patient function.

The manual torque wrench is a convenient tool for achieving the desired torque.

## Manual Torque Wrench – Surgical

Intended for tightening or adjusting implant position.

- Insert Implant Driver Wrench Adapter Brånemark System.



## Manual Torque Wrench – Prosthetic

Intended for retaining screws with a tightening torque of 15–35 Ncm. Compatible with all machine screwdrivers.

- Insert the applicable driver.



## Use of Manual Torque Wrench Surgical

- Assemble the torque wrench by inserting the implant driver.
- To tighten an implant, adjust the direction indicator so that the arrow is pointing toward the level arm and rotate clockwise.
- To loosen an implant, adjust the direction indicator so that the arrow is pointing away from the level arm and rotate counter-clockwise.

**Warning:** Using the wrench body instead of the level arm may result in excessive torque being transferred to the screw and/or implant site.

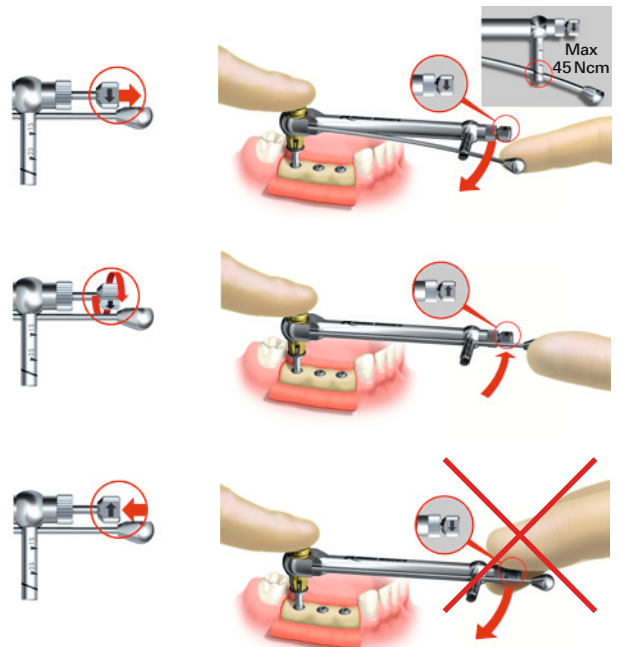

# Osteotomes

The osteotomes are intended to be used in soft bone.

After initial twist-drill preparation to identified depth, the osteotomes are used to manually form the site by compressing the bone laterally, resulting in a denser bone-to-implant interface, rather than removing valuable bone from the surgical site.

Nobel Biocare osteotomes incorporate a universal design and can be used with Brånemark System, NobelReplace Tapered and Straight, Replace Select Tapered and Straight, NobelActive, NobelSpeedy, and NobelDirect implants.

## Procedure

- Mark and drill the initial pilot holes with Drill  $\varnothing$  2 mm to full depth.
- Insert tip of osteotome  $\varnothing$  2.5 mm into pilot hole and push the instrument into the bone while rotating it, avoiding side-to-side or off-axis leverage. In denser bone, it may be necessary to use a mallet to tap the osteotome to the proper depth.
- Leave the osteotome in place for about 10 seconds to allow the bone to relax.
- Remove the osteotome by simultaneously rotating the tool and withdrawing it.
- Using the same technique, continue with osteotomes  $\varnothing$  3.0–5.0 mm to enlarge the site sequentially to the desired width and depth.

**Note:** The osteotome seating depths and diameters can vary from the standard procedure based on the judgement of the surgeon. In some situations, a stepped procedure may be used where the final osteotome is not seated to the full depth. This allows the tip of the implant to engage before the self-tapping delivery is begun.



The depth markings on the osteotomes correspond to the actual lengths: 8, 10, 13 and 16 mm.



# OsseoSet™ 200

## Drill unit

OsseoSet™ 200 SI-923, 230V	NB00900116
OsseoSet™ 200 SI-915, 115V (US)	NB00900117
OsseoSet™ 200 (WS-75) SI-923, 230V*	NB00900114

\* Version with Contra-angle handpiece WS-75 E/KM 20:1 that can be dismantled. This version is designed to meet the needs in markets where hygiene recommendations state the use of a handpiece that can be dismantled.



## Accessories

Contra-angle WI-75 E/KM 20:1	NB10207554
Contra-angle WS-75 E/KM 20:1**	NB10207513
Handpiece S-11, straight 1:1	NB00001104
OsseoSet™ 200 motor with cable	NB04720016
Omnirrigator 5-pack	32F1004
Hose Set for Machinery, 80 mm 10-pack	32F0128
Cannula internal cooling	NB02610500
Locking pin	NB04006800

\*\* Can be dismantled. Designed to meet the needs in markets where hygiene recommendations state the use of a handpiece that can be dismantled.

## Factory settings

Program	Type of treatment	Handpiece	Speed rpm	Adjustment range	Max torque Ncm	Implant system
P1	Oral surgery	S-11, 1:1	40.000	300–40.000 rpm	Max	Universal
P2	Implant site preparation	WI-75/WS-75, 20:1	2.000	15–2.000 rpm	Max	Universal (factory setting: Brånemark System®, NobelActive®, NobelReplace® Straight)
P3	Implant site preparation	WI-75/WS-75, 20:1	800	15–2.000 rpm	Max	Universal (factory setting: NobelReplace® Tapered)
P4 Forward (reverse)	Implant tapping/tightening	WI-75/WS-75, 20:1	30 (60***)	5–50 Ncm (5 Ncm stages)	50	Universal
P5 Forward (reverse)	Abutment and prosthetic screw tightening	WI-75/WS-75, 20:1	15 (20***)	5–50 Ncm (5 Ncm stages)	50	Universal

\*\*\* Settings in reverse mode.

# Drill stops

## Drill Stop Kit 32430

Kit includes	
Drill Stop Kit Box	33062
Drill Stop Ø 2 mm	33063
Drill Stop Ø 2.8 mm	33064
Drill Stop Ø 3 mm	33075
Drill Stop Ø 3.2 mm	33077
Drill Stop Ø 3.4 mm	33078
Drill Stop Ø 3.6 mm	33084
Drill Stop Ø 4.2 mm	33081



The drill stops allow for a safe and accurate surgical procedure by pre-determining the drill depth of twist drills and twist step drills. The kit is used to store, autoclave and facilitate the mounting of the drill stops.

### 1 Mount drill stop

- Slide drill stop onto corresponding drill.
- Place drill in mounting hole corresponding to desired drill depth. Use large holes for drills Ø 3.4 and above.



### 2 Tighten drill stop

Tighten the screw on the drill stop using Screwdriver Unigrip.



### 3 Drill to drill stop

Drill until predetermined drill depth is reached.



# Cleaning and sterilization

## Sterile components

The devices delivered sterile have a “Sterile” marking on the label. Opened packages of components that have never entered the oral cavity of a patient may be cleaned and sterilized/ autoclaved again, following the procedures stated below.



**Note:** Implants should never be re-sterilized.

## Implants

Implants are delivered sterile, are for single-use only, and must be used prior to the labeled expiration date. Do not use implants if the packaging has been damaged or previously opened.



## Twist and twist step drills, precision drill, screw taps and counterbores

The drills are disposable, delivered sterile, and should be discarded after use.



## Abutments and plastic copings

Multi-unit Abutment, Snappy Abutment, QuickTemp Abutment, and Immediate Temporary Abutment are delivered sterile. If re-sterilization is required, use steam sterilization for 5 minutes at 135°C/274°F.



### Notes:

- For re-sterilization of straight Multi-unit Abutment, remove plastic holder prior to procedure.
- Sterile plastic copings are for single-use only and should not be re-sterilized.



### Non-sterile components

Care and maintenance of reusable instruments are crucial for successful treatment. Well-maintained instruments not only safeguard your patients and staff against infection, but also are essential for the outcome of the total treatment.

### Surgical kit and kit box

For sterilization, use steam sterilization for 5 minutes at 135°C/274°F.



### Contra-angle

For cleaning and sterilization procedures, see specific instructions from respective manufacturer.

### Abutments and plastic copings

Abutments made of titanium, gold alloy, and plastic (PEEK) are delivered non-sterile. It is recommended to sterilize the abutment prior to placing it in the oral cavity. For sterilization, use steam sterilization for 5 minutes at 135°C/274°F.

#### Notes:

- If modifications have been made to the abutment, clean the abutment prior to sterilization.
- Non-sterile plastic copings should not be re-sterilized, as they are for single-use only.

### Zirconia abutments and Procera® Esthetic Abutment Selection Kit

Abutments and kit are delivered non-sterile. For sterilization, use steam sterilization for 5 minutes at 135°C/274°F.



## Instruments, impression copings in metal, manual torque wrench

### Pre-cleaning

1. Remove residual tissue or bone by immersing the used instruments in cold water (<math><40^{\circ}\text{C}/104^{\circ}\text{F}</math>). Do not use fixation agents or hot water (>math>>40^{\circ}\text{C}/104^{\circ}\text{F}</math>) as this could influence subsequent cleaning results. Instruments should be kept in a wet environment until the next step is initiated.
2. Soak the instruments in 0.5% enzymatic cleaning solution (e.g enzymatic detergent with a pH level between 6–9) prepared with luke warm tap water for 5 minutes. Cleaning agents are available commercially. Please ask your supplier for details.
3. Scrub the outer, and if applicable also inner side of the instruments with a suitable soft-bristled nylon brush until all visible soil is removed.
4. Rinse outer and inner sides of the instruments with tap water to remove all cleaning solution.

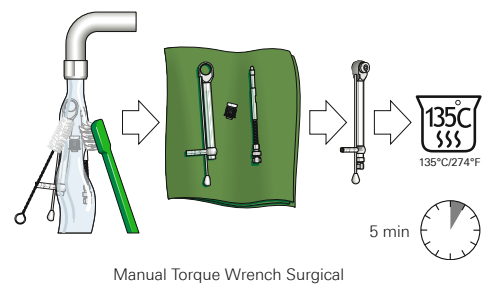

### Automated cleaning, disinfection, and drying

1. Place the instruments on an instrument rack and load the instrument rack into the washer/disinfector. Start the cycle by applying the following:
  - a. 2 minutes pre-cleaning with cold water and emptying.
  - b. 5 minutes cleaning at 55°C/131°F with 0.5% cleaner Neodisher mediclean (Enzyme, NTA, Tenside) or equivalent (if Neodisher mediclean is not available in your market) and emptying.
  - c. 3 minutes neutralization with tap water and emptying.
  - d. 2 minutes intermediate rinsing with cold tap water and emptying.
2. Special instructions provided by the manufacturers of automated washing machines must be followed. Cleaning disinfectants are available commercially.



3. Dry the outer side of the instruments through drying cycle of washer/disinfector.
4. If needed, additional manual drying can be performed with a lint-free towel. Insufflate cavities of instruments by using sterile compressed air.

### Functional testing and maintenance

Visually inspect for cleanliness with magnifying glasses. If necessary, perform reprocessing process again until the instruments are visibly clean.

### Packaging

Place instruments in sterilization packets.

### Sterilization

Sterilize the instruments by applying a fractionated pre-vacuum process (according to ISO 13060 / ISO 17665) following any respective country requirements.

*Parameters for the pre-vacuum cycle:*

- 3 pre-vacuum phases with at least 60 millibar

*New cycle:*

- Heat up to a minimum sterilization temperature of 132°C–134°C/269.6°F–273.2°F
- Maximum temperature: 135°C/274°F
- Minimum holding time: 3 minutes
- Drying time: minimum 10 minutes

### Storage

Store sterilized instruments in a dry, clean and dust-free environment at modest temperatures of 5°C to 40°C/41°F–104°F.

---

### Cover Screw Mill

1. Unscrew the screw on the back of the handle and remove the handle.
2. Remove the spring.
3. Remove the pin.
4. Clean the Cover Screw Mill as described above.
5. Let the items dry completely before re-assembling.
6. Sterilize as described above.

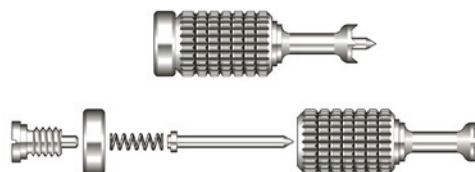

# Customer service worldwide

## Americas

### Brazil

Nobel Biocare Brazil  
Phone: 0800 16 999 6

### Canada

Nobel Biocare Canada  
Phone: +1 800 939 9394

### Chile

Dental Biocare  
Phone: +56 220 19282

### Colombia

Hospimedics S.A.  
Phone: +57 1 640 0608

### Mexico

Nobel Biocare Mexico  
Phone: +52 55 524 974 60

### USA

Nobel Biocare USA  
Phone: +1 800 322 5001

## Asia Pacific

### Australia

Nobel Biocare Australia  
Phone: 1800 804 597

### China

Nobel Biocare China  
Phone: +86 21 5206 6655

### Hong Kong

Nobel Biocare Hong Kong  
Phone: +852 2845 1266

### India

Nobel Biocare India  
Phone: 1800 266 9998

### Japan

Nobel Biocare Japan  
Phone: +81 3 6717 6191

### New Zealand

Nobel Biocare New Zealand  
Phone: 0800 441 657

### Singapore

Nobel Biocare Singapore  
Phone: +65 6737 7967

### Taiwan

Nobel Biocare Taiwan  
Phone: +886 080 00 779

## Europe, Middle East and Africa

### Austria

Nobel Biocare Austria  
Phone: +43 1 892 89 90

### Belgium

Nobel Biocare Belgium  
Phone: +32 2 467 41 70

### Denmark

Nobel Biocare Denmark  
Phone: +45 39 40 48 46

### Finland

Nobel Biocare Finland  
Phone: +358 20 740 61 00

### France

Nobel Biocare France  
Phone: +33 1 49 20 00 30

### Germany

Nobel Biocare Germany  
Phone: +49 221 500 850

### Hungary

Nobel Biocare Hungary  
Phone: +36 1 279 33 79

### Ireland

Nobel Biocare Ireland  
Phone: 1800 677 306

### Italy

Nobel Biocare Italy  
Phone: +39 800 53 93 28

### Lithuania

Nobel Biocare Lithuania  
Phone: +370 5 268 3448

### Netherlands

Nobel Biocare Netherlands  
Phone: +31 30 635 49 49

### Norway

Nobel Biocare Norway  
Phone: +47 23 24 98 30

### Poland

Nobel Biocare Poland  
Phone: +48 22 549 93 52

### Portugal

Nobel Biocare Portugal  
Phone: +351 800 300 100

## Russia

Nobel Biocare Russia  
Phone: +7 495 974 77 55

## South Africa

Nobel Biocare South Africa  
Phone: +27 11 802 0112

## Spain

Nobel Biocare Spain  
Phone: +34 900 850 008

## Sweden

Nobel Biocare Sweden  
Phone: +46 31 81 88 00

## Switzerland

Nobel Biocare Switzerland  
Phone: 0800 211 424

## United Kingdom

Nobel Biocare UK  
Phone: +44 208 756 3300

## Distributor markets

**Bulgaria, Croatia, Cyprus, Czech Republic, Greece, Iran, Jordan, Kuwait, Lebanon, Malta, Romania, Saudi Arabia, Serbia, Slovenia, Turkey, United Arab Emirates**  
Phone: +48 22 549 93 55

